

MINIATURE RELAY

2 POLES - 1 to 2A (for signal switching)

RY Series

■ FEATURES

- Ultra high sensitivity
- UL, CSA recognized (see note 2)
- Conforms to FCC rules and regulations Part 68
 - Surge strength 1,500 V
- High dielectric strength type available (RY-WF type)
- Contact arrangement MBB type available (RY-D type)
- High reliability-bifurcated contacts
- Wide operating range
- DIL terminals
- Plastic sealed type, cat III
- RoHS compliant.

Please see page 9 for more information

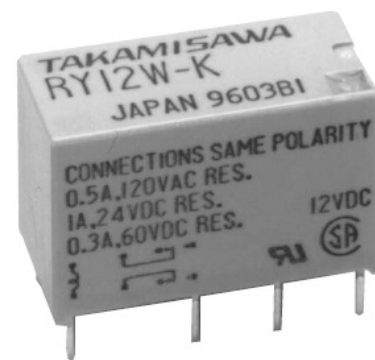

■ PARTNUMBER INFORMATION

[Example] $\frac{\text{RY}}{\text{(a)}}$ - $\frac{12}{(*)}$ $\frac{\text{WF}}{\text{(c)}}$ - $\frac{\text{K}}{\text{(d)}}$

(a)	Relay type	RY	: RY-Series
(b)	Coil rated voltage	012	: 3.....48 VDC Coil rating table at page 3
(c)	Coil and contact type	W WZ WF WFZ D	: High sensitive type : Nominal 0.5W type : High dielectric strength type : 2A type : 2 form D (2 MMB type)
(d)	Enclosure	K	: Plastic sealed type

Note 1: Actual marking omits the hyphen (-) of (*)

For movable and stationary contact with gold overlay type, add suffix "-OH".

Note 2: Standard relay does not bear the UL/CSA marking.

In case UL/CSA certification is necessary, add -UL to the ordering partnumber.

RY SERIES

■ SPECIFICATION

Item		High sensitive type	500 mW type	High dielectric strength	2 A type	Continuous (MBB) type	
		RY-()W-K	RY-()WZ-K	RY-()WF-K	RY-()WFZ-K	RY-()D-K	
Contact Data	Configuration	2 form C (DPDT)				2 form D (2 MBB)	
	Construction	Bifurcated (cross bar)				Single	
	Material	Gold overlay silver-palladium			Gold overlay silver-nickel	Gold overlay silver-palladium	
	Resistance (initial)	Max. 100 mΩ at 6 VDC, 1A					
	Contact rating	1A, 24VDC 0.5A, 120VAC		1A, 24VDC 0.25A, 120VAC	2A, 30VDC 0.5A, 125VAC	0.15A, 48VDC 0.3A, 120VAC	
	Max. carrying current	1.25A			2A	0.6A	
	Max. switching voltage	120VAC, 60VDC			125VAC, 150VDC	120VAC, 60VDC	
	Max. switching power	60VA / 24W		30VA / 24W	62.5VA / 60W	36VA / 7.2W	
	Max. switching current	1A					
	Min. switching load *	0.01 mA, 10 mVDC				0.1 mA, 10 mVDC	
	Capacitance (at 10MHz)	Approximately 0.9 pF (open contacts), 1.4pF (adjacent contacts) Approximately 1.9 pF (between coil and contacts)					
Life	Mechanical	Min. 20 x 10 ⁶ operations	Min. 10 x 10 ⁶ operations			Min. 1 x 10 ⁶ operations	
	Electrical (at contact rating)	Min. 200 x 10 ³ operations (0.5A, 120VAC) Min. 500 x 10 ³ operations (1A, 24VDC)	Min. 500x10 ³ operations (0.25A, 120VAC) (1A, 4VDC)	Min. 100x10 ³ operations (2A, 30VDC)	Min.200x10 ³ ops. (0.3A, 120VAC) Min.500x10 ³ ops. (0.15A, 48VDC)		
Coil Data	Rated power	150 - 300mW	500 - 580mW	450 - 460mW	500 - 580mW	450 - 480mW	
	Operate power	75 - 140mW	125 - 145mW	200 - 210mW	200 - 324mW	200 - 210mW	
	Operating temperature range (no frost)	-30 °C to +90 °C (+80 °C for 48VDC type)	-30 °C to +60 °C			-30 °C to +70 °C (+65 °C for 48VDC type)	

* Minimum switching loads mentioned above are reference values. Please perform the confirmation test with actual load before production since reference values may vary according to switching frequencies, environmental conditions and expected reliability levels.

■ SPECIFICATION (CONTINUED)

Item			High sensitive type	500 mW type	High dielectric strength	2 A type	Continuous (MBB) type
			RY-()W-K	RY-()WZ-K	RY-()WF-K	RY-()WFZ-K	RY-()D-K
Timing Data	Operate (at nominal voltage)		Max. 6 ms				
	Release (at nominal voltage)		Max. 3 ms				
Insulation	Resistance (initial)		Min. 1,000MΩ at 500VDC				
	Dielectric strength	Open contacts	500VAC, 1min	1,000VAC, 1min.	500VAC, 1min		
		Contacts to coil/ adjacent contacts	1,000VAC 1min				
	Surge strength	Coil to contacts	1,500V / 10 x 160μs standard wave				
Other	Vibration resistance	Misoperation	10 to 55Hz double amplitude 1.5 mm				
		Endurance	10 to 55Hz double amplitude 4.5 mm				
	Shock resistance	Misoperation	Min. 100m/s ² (11 ± 1ms)				
		Endurance	Min. 1,000m/s ² (6 ± 1ms)				
	Weight	Approximately 5 g					
	Sealing	Sealed cat. RTIII					

■ COIL RATING

High sensitive type (RY-xxW-K)

Coil Code	Rated Coil Voltage (VDC)	Coil Resistance +/- 10% (Ohm)	Must Operate Voltage (VDC) *	Must Release Voltage (VDC) *	Rated Power (mW)
3	3	60	2.1	0.15	150
4.5	4.5	135	3.2	0.23	
5	5	165	3.6	0.25	
6	6	240	4.3	0.3	
9	9	540	6.4	0.45	
12	12	960	8.5	0.6	200
18	18	1,620	12.6	0.9	
24	24	2,880	16.8	1.2	300
48	48	7,680	32.6	2.4	

Note: All values in the table are valid for 20°C and zero contact current.

* Specified operate values are valid for pulse wave voltage.

RY SERIES

500 mW type (RY-xxWZ-K)

Coil Code	Rated Coil Voltage (VDC)	Coil Resistance +/- 10% (Ohm)	Must Operate Voltage (VDC) *	Must Release Voltage (VDC) *	Rated Power (mW)
3	3	18	1.5	0.15	500
4.5	4.5	36	2.25	0.23	560
5	5	45	2.5	0.25	
6	6	66	3	0.3	550
9	9	140	4.5	0.45	580
12	12	280	6	0.6	510
18	18	560	9	0.9	580
24	24	1,070	12	1.2	540
48	48	4,000	24	2.4	580

High dielectric type (RY-xxWF-K)

Coil Code	Rated Coil Voltage (VDC)	Coil Resistance +/- 10% (Ohm)	Must Operate Voltage (VDC) *	Must Release Voltage (VDC) *	Rated Power (mW)
5	5	56	3.3	0.25	450
6	6	80	4	0.3	
9	9	180	6	0.45	
12	12	320	8	0.6	
18	18	720	12	0.9	
24	24	1,260	15.9	1.2	
48	48	5,000	33	2.4	460

2A type (RY-xxWFZ-K)

Coil Code	Rated Coil Voltage (VDC)	Coil Resistance +/- 10% (Ohm)	Must Operate Voltage (VDC) *	Must Release Voltage (VDC) *	Rated Power (mW)
3	3	18	1.9	0.15	500
4.5	4.5	36	2.9	0.23	560
5	5	45	3.2	0.25	
6	6	66	3.8	0.3	550
9	9	140	5.7	0.45	580
12	12	280	7.6	0.6	510
18	18	560	11.4	0.9	580
24	24	1,070	15.2	1.2	540
48	48	4,000	36	2.4	580

Note: All values in the tables are measured at 20°C and zero contact current.

* Specified values are measured with pulse wave voltage

MBB type (RY-xxD-K)

Coil Code	Rated Coil Voltage (VDC)	Coil Resistance +/- 10% (Ohm)	Must Operate Voltage (VDC) *	Must Release Voltage (VDC) *	Rated Power (mW)
4.5	4.5	45	3	0.23	450
5	5	55	3.3	0.25	
6	6	80	3.95	0.3	
9	9	180	5.9	0.45	
12	12	320	7.9	0.6	
18	18	720	11.8	0.9	
24	24	1,280	15.8	1.2	480
48	48	4,800	31.8	2.4	

Note: All values in the table are measured at 20°C and zero contact current.

* Specified values are measured with pulse wave voltage

■ SAFETY STANDARDS *

Type	Compliance	Contact rating
UL	UL 478, UL 508	Flammability: UL 94-V0 (plastics)
	E 45026	[RY-W, RY-WZ] 0.5A, 120VAC (resistive)
CSA	C22.2 No. 14 LR 35579	1A, 24VDC (resistive)
		0.3A, 60VDC (resistive)
		2A, 30VDC, (resistive)
		[RY-WF]
		0,5A,120VAC (resistive)(UL)
		0.25A, 120VAC (resistive)(CSA)
		1A, 24VDC (resistive)
		0.3A, 60VDC (resistive)
		2A, 30VDC (resistive)
		[RY-D]
		0.3A, 120VAC (resistive)
		0.2A, 60VDC (resistive)
[RY-WFZ]		
0.5A, 125VAC (resistive)		
2A, 30VDC (resistive)		
		0.6A, 110VDC (resistive)

* Note: for UL/CSA certified relays; UL/CSA marking, add -UL to the ordering partnumber

CHARACTERISTIC DATA

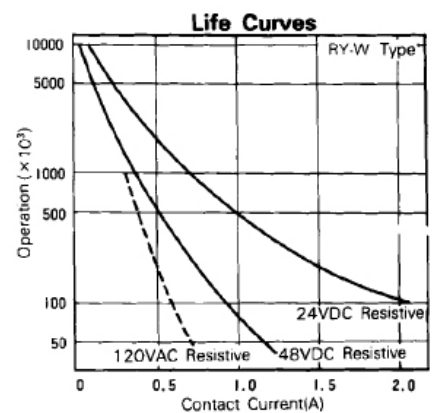
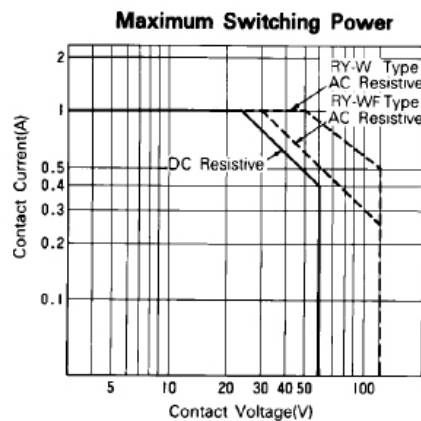
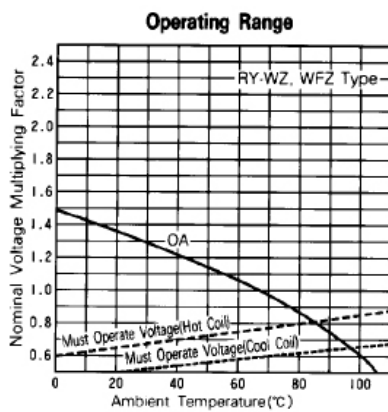
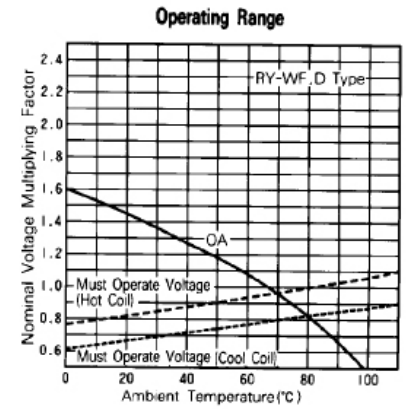
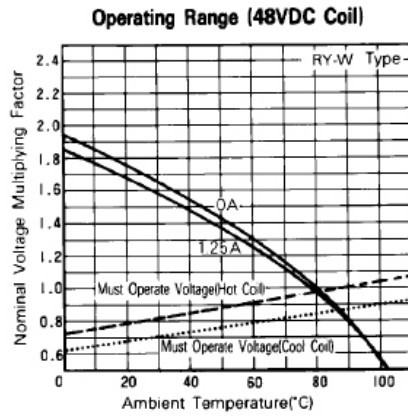
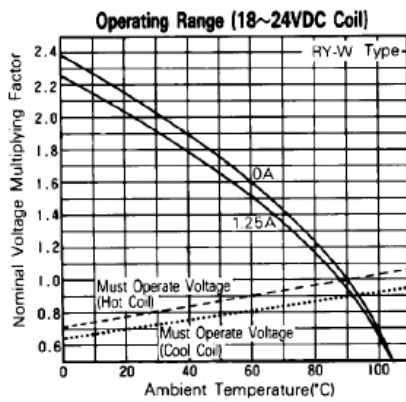
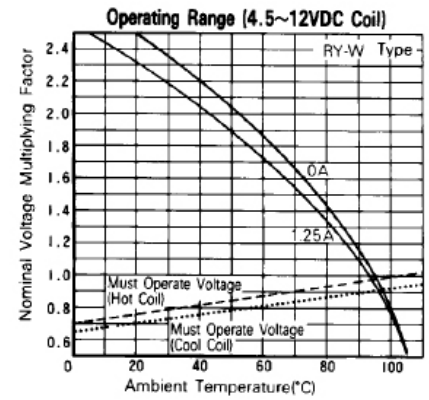
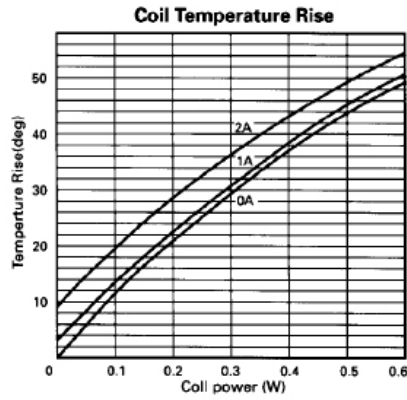
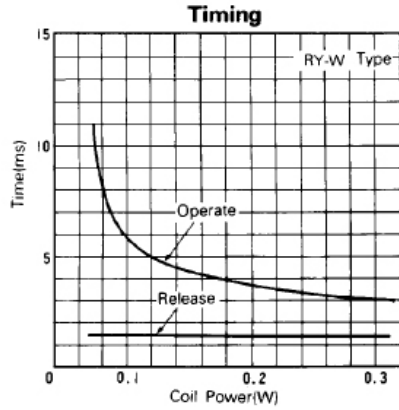

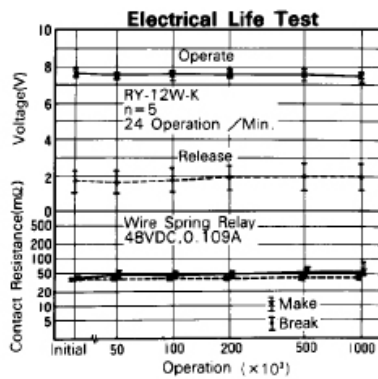
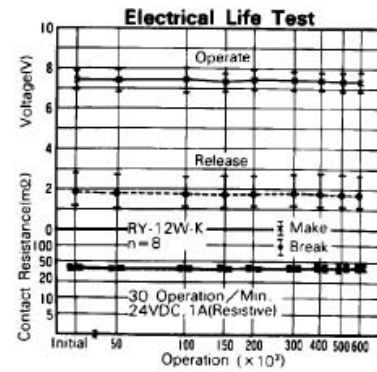
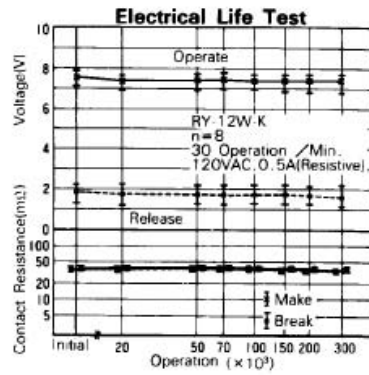
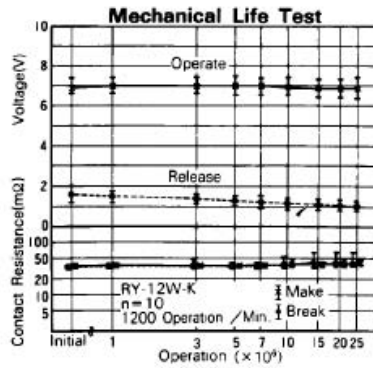
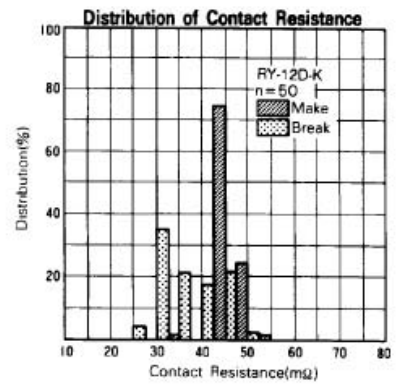
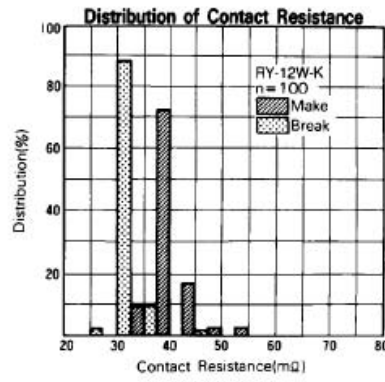
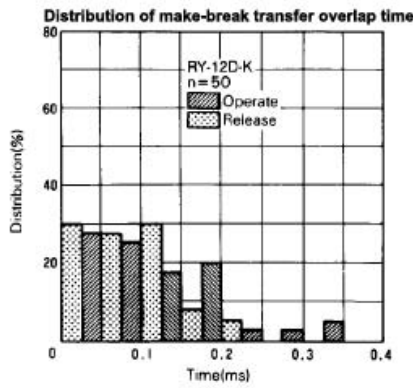
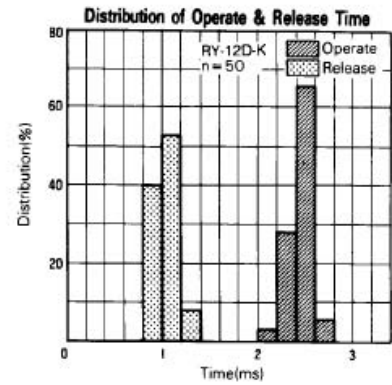
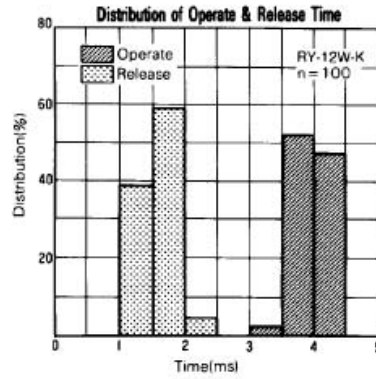
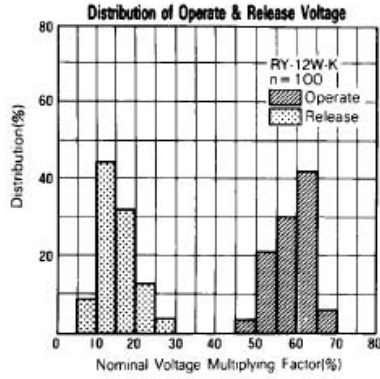

■ DIMENSIONS

● Dimensions

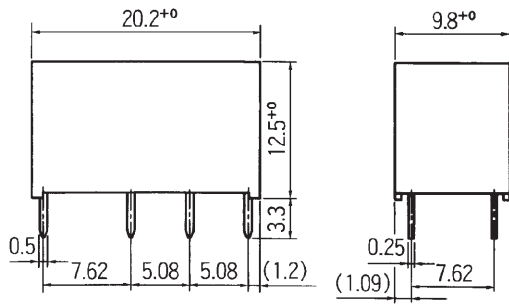

● Schematics (BOTTOM VIEW)

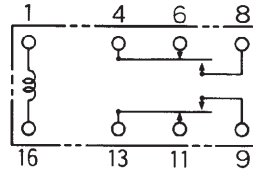

● PC board mounting hole layout (BOTTOM VIEW)

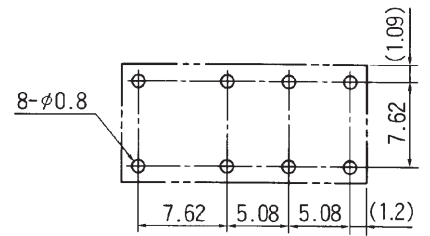

Unit: mm

RoHS Compliance and Lead Free Information

1. General Information

- All relays produced by Fujitsu Components are compliant with RoHS directive 2011/65/EU including amendments.
- Cadmium as used in electrical contacts is exempted from the RoHS directives. As per Annex III of directive 2011/65/EU.
- All relays are lead-free. Please refer to Lead-Free Status Info for older date codes at: <http://www.fujitsu.com/downloads/MICRO/fcai/relays/lead-free-letter.pdf>
- Lead free solder plating on relay terminals is Sn-3.0Ag-0.5Cu, unless otherwise specified. This material has been verified to be compatible with PbSn assembly process.

2. Recommended Lead Free Solder Condition

- Recommended solder Sn-3.0Ag-0.5Cu.

Flow Solder Condition:

Pre-heating: maximum 120°C within 90 sec.
 Soldering: dip within 5 sec. at 255°C ± 5°C solder bath
 Relay must be cooled by air immediately after soldering

Solder by Soldering Iron:

Soldering Iron 30-60W
 Temperature: maximum 350-360°C
 Duration: maximum 3 sec.

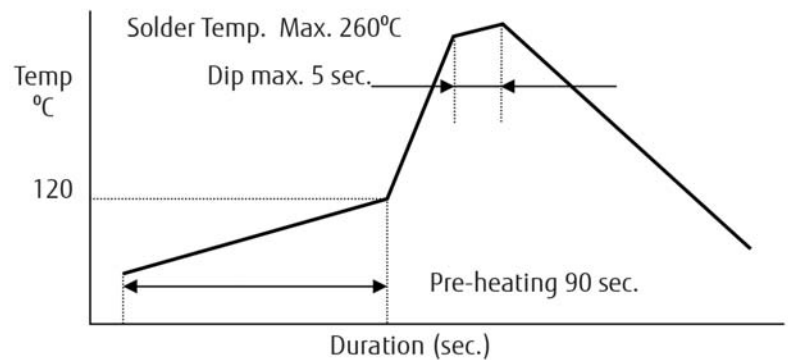

We highly recommend that you confirm your actual solder conditions

3. Moisture Sensitivity

- Moisture Sensitivity Level standard is not applicable to electromechanical relays, unless otherwise indicated.

4. Tin Whiskers

- Dipped SnAgCu solder is known as presenting a low risk to tin whisker development. No considerable length whisker was found by our in house test.

Fujitsu Components International Headquarter Offices

<p>Japan Fujitsu Component Limited Gotanda-Chuo Building 3-5, Higashigotanda 2-chome, Shinagawa-ku Tokyo 141, Japan Tel: (81-3) 5449-7010 Fax: (81-3) 5449-2626 Email: promothq@ft.ed.fujitsu.com Web: www.fcl.fujitsu.com</p>	<p>Europe Fujitsu Components Europe B.V. Diamantlaan 25 2132 WV Hoofddorp Netherlands Tel: (31-23) 5560910 Fax: (31-23) 5560950 Email: info@fceu.fujitsu.com Web: emea.fujitsu.com/components/</p>
<p>North and South America Fujitsu Components America, Inc. 250 E. Caribbean Drive Sunnyvale, CA 94089 U.S.A. Tel: (1-408) 745-4900 Fax: (1-408) 745-4970 Email: components@us.fujitsu.com Web: http://us.fujitsu.com/components</p>	<p>Asia Pacific Fujitsu Components Asia Ltd. 102E Pasir Panjang Road #01-01 Citilink Warehouse Complex Singapore 118529 Tel: (65) 6375-8560 Fax: (65) 6273-3021 Email: fcal@fcal.fujitsu.com Web: http://www.fujitsu.com/sg/services/micro/components/</p>

©2014 Fujitsu Components Europe B.V. All rights reserved. All trademarks or registered trademarks are the property of their respective owners.

The contents, data and information in this datasheet are provided by Fujitsu Component Ltd. as a service only to its user and only for general information purposes.

The use of the contents, data and information provided in this datasheet is at the users' own risk.

Fujitsu has assembled this datasheet with care and will endeavor to keep the contents, data and information correct, accurate, comprehensive, complete and up to date.

Fujitsu Components Europe B.V. and affiliated companies do however not accept any responsibility or liability on their behalf, nor on behalf of its employees, for any loss or damage, direct, indirect or consequential, with respect to this datasheet, its contents, data, and information and related graphics and the correctness, reliability, accuracy, comprehensiveness, usefulness, availability and completeness thereof.

Nor do Fujitsu Components Europe B.V. and affiliated companies accept on their behalf, nor on behalf of its employees, any responsibility or liability for any representation or warrant of any kind, express or implied, including warranties of any kind for merchantability or fitness for particular use, with respect to these datasheets, its contents, data, information and related graphics and the correctness, reliability, accuracy, comprehensiveness, usefulness, availability and completeness thereof. Rev. August 04, 2014