



8086

16-BIT HMOS MICROPROCESSOR

8086/8086-2/8086-1

- Direct Addressing Capability 1 MByte of Memory
- Architecture Designed for Powerful Assembly Language and Efficient High Level Languages
- 14 Word, by 16-Bit Register Set with Symmetrical Operations
- 24 Operand Addressing Modes
- Bit, Byte, Word, and Block Operations
- 8 and 16-Bit Signed and Unsigned Arithmetic in Binary or Decimal Including Multiply and Divide
- Range of Clock Rates:
 - 5 MHz for 8086,
 - 8 MHz for 8086-2,
 - 10 MHz for 8086-1
- MULTIBUS System Compatible Interface
- Available in EXPRESS
 - Standard Temperature Range
 - Extended Temperature Range
- Available in 40-Lead Cerdip and Plastic Package
 - (See Packaging Spec. Order #231389)

The Intel 8086 high performance 16-bit CPU is available in three clock rates: 5, 8 and 10 MHz. The CPU is implemented in N-Channel, depletion load, silicon gate technology (HMOS-III), and packaged in a 40-pin CERDIP or plastic package. The 8086 operates in both single processor and multiple processor configurations to achieve high performance levels.

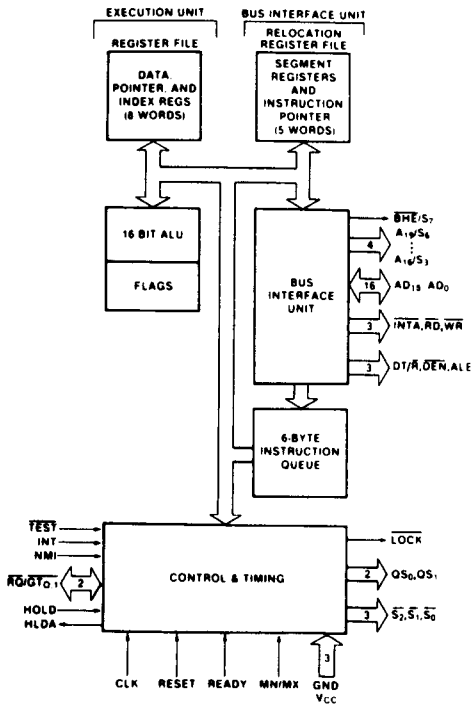
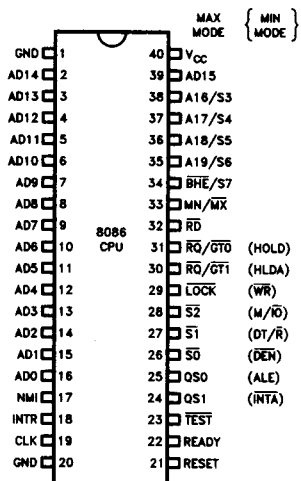

Figure 1. 8086 CPU Block Diagram

231455-1



40 Lead
Figure 2. 8086 Pin Configuration

231455-2

Table 1. Pin Description

The following pin function descriptions are for 8086 systems in either minimum or maximum mode. The "Local Bus" in these descriptions is the direct multiplexed bus interface connection to the 8086 (without regard to additional bus buffers).

Symbol	Pin No.	Type	Name and Function																		
AD ₁₅ -AD ₀	2-16, 39	I/O	ADDRESS DATA BUS: These lines constitute the time multiplexed memory/I/O address (T ₁), and data (T ₂ , T ₃ , T _W , T ₄) bus. A ₀ is analogous to BHE for the lower byte of the data bus, pins D ₇ -D ₀ . It is LOW during T ₁ when a byte is to be transferred on the lower portion of the bus in memory or I/O operations. Eight-bit oriented devices tied to the lower half would normally use A ₀ to condition chip select functions. (See BHE.) These lines are active HIGH and float to 3-state OFF during interrupt acknowledge and local bus "hold acknowledge".																		
A ₁₉ /S ₆ , A ₁₈ /S ₅ , A ₁₇ /S ₄ , A ₁₆ /S ₃	35-38	O	ADDRESS/STATUS: During T ₁ these are the four most significant address lines for memory operations. During I/O operations these lines are LOW. During memory and I/O operations, status information is available on these lines during T ₂ , T ₃ , T _W , T ₄ . The status of the interrupt enable FLAG bit (S ₅) is updated at the beginning of each CLK cycle. A ₁₇ /S ₄ and A ₁₆ /S ₃ are encoded as shown. This information indicates which relocation register is presently being used for data accessing. These lines float to 3-state OFF during local bus "hold acknowledge."																		
			<table border="1"> <thead> <tr> <th>A₁₇/S₄</th> <th>A₁₆/S₃</th> <th>Characteristics</th> </tr> </thead> <tbody> <tr> <td>0 (LOW)</td> <td>0</td> <td>Alternate Data</td> </tr> <tr> <td>0</td> <td>1</td> <td>Stack</td> </tr> <tr> <td>1 (HIGH)</td> <td>0</td> <td>Code or None</td> </tr> <tr> <td>1</td> <td>1</td> <td>Data</td> </tr> <tr> <td>S₆ is 0 (LOW)</td> <td></td> <td></td> </tr> </tbody> </table>	A ₁₇ /S ₄	A ₁₆ /S ₃	Characteristics	0 (LOW)	0	Alternate Data	0	1	Stack	1 (HIGH)	0	Code or None	1	1	Data	S ₆ is 0 (LOW)		
A ₁₇ /S ₄	A ₁₆ /S ₃	Characteristics																			
0 (LOW)	0	Alternate Data																			
0	1	Stack																			
1 (HIGH)	0	Code or None																			
1	1	Data																			
S ₆ is 0 (LOW)																					
BHE/S ₇	34	O	BUS HIGH ENABLE/STATUS: During T ₁ the bus high enable signal (BHE) should be used to enable data onto the most significant half of the data bus, pins D ₁₅ -D ₈ . Eight-bit oriented devices tied to the upper half of the bus would normally use BHE to condition chip select functions. BHE is LOW during T ₁ for read, write, and interrupt acknowledge cycles when a byte is to be transferred on the high portion of the bus. The S ₇ status information is available during T ₂ , T ₃ , and T ₄ . The signal is active LOW, and floats to 3-state OFF in "hold". It is LOW during T ₁ for the first interrupt acknowledge cycle.																		
			<table border="1"> <thead> <tr> <th>BHE</th> <th>A₀</th> <th>Characteristics</th> </tr> </thead> <tbody> <tr> <td>0</td> <td>0</td> <td>Whole word</td> </tr> <tr> <td>0</td> <td>1</td> <td>Upper byte from/to odd address</td> </tr> <tr> <td>1</td> <td>0</td> <td>Lower byte from/to even address</td> </tr> <tr> <td>1</td> <td>1</td> <td>None</td> </tr> </tbody> </table>	BHE	A ₀	Characteristics	0	0	Whole word	0	1	Upper byte from/to odd address	1	0	Lower byte from/to even address	1	1	None			
BHE	A ₀	Characteristics																			
0	0	Whole word																			
0	1	Upper byte from/to odd address																			
1	0	Lower byte from/to even address																			
1	1	None																			
RD	32	O	READ: Read strobe indicates that the processor is performing a memory or I/O read cycle, depending on the state of the S ₂ pin. This signal is used to read devices which reside on the 8086 local bus. RD is active LOW during T ₂ , T ₃ and T _W of any read cycle, and is guaranteed to remain HIGH in T ₂ until the 8086 local bus has floated. This signal floats to 3-state OFF in "hold acknowledge".																		

Table 1. Pin Description (Continued)

Symbol	Pin No.	Type	Name and Function
READY	22	I	READY: is the acknowledgement from the addressed memory or I/O device that it will complete the data transfer. The READY signal from memory/I/O is synchronized by the 8284A Clock Generator to form READY. This signal is active HIGH. The 8086 READY input is not synchronized. Correct operation is not guaranteed if the setup and hold times are not met.
INTR	18	I	INTERRUPT REQUEST: is a level triggered input which is sampled during the last clock cycle of each instruction to determine if the processor should enter into an interrupt acknowledge operation. A subroutine is vectored to via an interrupt vector lookup table located in system memory. It can be internally masked by software resetting the interrupt enable bit. INTR is internally synchronized. This signal is active HIGH.
$\overline{\text{TEST}}$	23	I	TEST: input is examined by the "Wait" instruction. If the $\overline{\text{TEST}}$ input is LOW execution continues, otherwise the processor waits in an "Idle" state. This input is synchronized internally during each clock cycle on the leading edge of CLK.
NMI	17	I	NON-MASKABLE INTERRUPT: an edge triggered input which causes a type 2 interrupt. A subroutine is vectored to via an interrupt vector lookup table located in system memory. NMI is not maskable internally by software. A transition from LOW to HIGH initiates the interrupt at the end of the current instruction. This input is internally synchronized.
RESET	21	I	RESET: causes the processor to immediately terminate its present activity. The signal must be active HIGH for at least four clock cycles. It restarts execution, as described in the Instruction Set description, when RESET returns LOW. RESET is internally synchronized.
CLK	19	I	CLOCK: provides the basic timing for the processor and bus controller. It is asymmetric with a 33% duty cycle to provide optimized internal timing.
V_{CC}	40		V_{CC}: +5V power supply pin.
GND	1, 20		GROUND
MN/ $\overline{\text{MX}}$	33	I	MINIMUM/MAXIMUM: indicates what mode the processor is to operate in. The two modes are discussed in the following sections.

3

The following pin function descriptions are for the 8086/8288 system in maximum mode (i.e., MN/ $\overline{\text{MX}}$ = V_{SS}). Only the pin functions which are unique to maximum mode are described; all other pin functions are as described above.

$\overline{S_2}, \overline{S_1}, \overline{S_0}$	26-28	O	STATUS: active during T_4 , T_1 , and T_2 and is returned to the passive state (1, 1, 1) during T_3 or during T_W when READY is HIGH. This status is used by the 8288 Bus Controller to generate all memory and I/O access control signals. Any change by $\overline{S_2}$, $\overline{S_1}$, or $\overline{S_0}$ during T_4 is used to indicate the beginning of a bus cycle, and the return to the passive state in T_3 or T_W is used to indicate the end of a bus cycle.
--	-------	---	---

Table 1. Pin Description (Continued)

Symbol	Pin No.	Type	Name and Function																																	
$\overline{S_2}, \overline{S_1}, \overline{S_0}$ (Continued)	26-28	O	These signals float to 3-state OFF in "hold acknowledge". These status lines are encoded as shown.																																	
			<table border="1"> <thead> <tr> <th>$\overline{S_2}$</th> <th>$\overline{S_1}$</th> <th>$\overline{S_0}$</th> <th>Characteristics</th> </tr> </thead> <tbody> <tr> <td>0 (LOW)</td> <td>0</td> <td>0</td> <td>Interrupt Acknowledge</td> </tr> <tr> <td>0</td> <td>0</td> <td>1</td> <td>Read I/O Port</td> </tr> <tr> <td>0</td> <td>1</td> <td>0</td> <td>Write I/O Port</td> </tr> <tr> <td>0</td> <td>1</td> <td>1</td> <td>Halt</td> </tr> <tr> <td>1 (HIGH)</td> <td>0</td> <td>0</td> <td>Code Access</td> </tr> <tr> <td>1</td> <td>0</td> <td>1</td> <td>Read Memory</td> </tr> <tr> <td>1</td> <td>1</td> <td>0</td> <td>Write Memory</td> </tr> <tr> <td>1</td> <td>1</td> <td>1</td> <td>Passive</td> </tr> </tbody> </table>	$\overline{S_2}$	$\overline{S_1}$	$\overline{S_0}$	Characteristics	0 (LOW)	0	0	Interrupt Acknowledge	0	0	1	Read I/O Port	0	1	0	Write I/O Port	0	1	1	Halt	1 (HIGH)	0	0	Code Access	1	0	1	Read Memory	1	1	0	Write Memory	1
$\overline{S_2}$	$\overline{S_1}$	$\overline{S_0}$	Characteristics																																	
0 (LOW)	0	0	Interrupt Acknowledge																																	
0	0	1	Read I/O Port																																	
0	1	0	Write I/O Port																																	
0	1	1	Halt																																	
1 (HIGH)	0	0	Code Access																																	
1	0	1	Read Memory																																	
1	1	0	Write Memory																																	
1	1	1	Passive																																	
$\overline{RQ}/\overline{GT}_0$, $\overline{RQ}/\overline{GT}_1$	30, 31	I/O	<p>REQUEST/GRANT: pins are used by other local bus masters to force the processor to release the local bus at the end of the processor's current bus cycle. Each pin is bidirectional with $\overline{RQ}/\overline{GT}_0$ having higher priority than $\overline{RQ}/\overline{GT}_1$. $\overline{RQ}/\overline{GT}$ pins have internal pull-up resistors and may be left unconnected. The request/grant sequence is as follows (see Page 2-24):</p> <ol style="list-style-type: none"> 1. A pulse of 1 CLK wide from another local bus master indicates a local bus request ("hold") to the 8086 (pulse 1). 2. During a T_4 or T_1 clock cycle, a pulse 1 CLK wide from the 8086 to the requesting master (pulse 2), indicates that the 8086 has allowed the local bus to float and that it will enter the "hold acknowledge" state at the next CLK. The CPU's bus interface unit is disconnected logically from the local bus during "hold acknowledge". 3. A pulse 1 CLK wide from the requesting master indicates to the 8086 (pulse 3) that the "hold" request is about to end and that the 8086 can reclaim the local bus at the next CLK. <p>Each master-master exchange of the local bus is a sequence of 3 pulses. There must be one dead CLK cycle after each bus exchange. Pulses are active LOW.</p> <p>If the request is made while the CPU is performing a memory cycle, it will release the local bus during T_4 of the cycle when all the following conditions are met:</p> <ol style="list-style-type: none"> 1. Request occurs on or before T_2. 2. Current cycle is not the low byte of a word (on an odd address). 3. Current cycle is not the first acknowledge of an interrupt acknowledge sequence. 4. A locked instruction is not currently executing. <p>If the local bus is idle when the request is made the two possible events will follow:</p> <ol style="list-style-type: none"> 1. Local bus will be released during the next clock. 2. A memory cycle will start within 3 clocks. Now the four rules for a currently active memory cycle apply with condition number 1 already satisfied. 																																	
LOCK	29	O	<p>LOCK: output indicates that other system bus masters are not to gain control of the system bus while LOCK is active LOW. The LOCK signal is activated by the "LOCK" prefix instruction and remains active until the completion of the next instruction. This signal is active LOW, and floats to 3-state OFF in "hold acknowledge".</p>																																	

Table 1. Pin Description (Continued)

Symbol	Pin No.	Type	Name and Function		
QS ₁ , QS ₀	24, 25	O	QUEUE STATUS: The queue status is valid during the CLK cycle after which the queue operation is performed. QS ₁ and QS ₀ provide status to allow external tracking of the internal 8086 instruction queue.		
			QS ₁	QS ₀	Characteristics
			0 (LOW)	0	No Operation
			0	1	First Byte of Op Code from Queue
1 (HIGH)	0	Empty the Queue			
1	1	Subsequent Byte from Queue			

The following pin function descriptions are for the 8086 in minimum mode (i.e., $MN/\overline{MX} = V_{CC}$). Only the pin functions which are unique to minimum mode are described; all other pin functions are as described above.

M/ \overline{IO}	28	O	STATUS LINE: logically equivalent to S ₂ in the maximum mode. It is used to distinguish a memory access from an I/O access. M/ \overline{IO} becomes valid in the T ₄ preceding a bus cycle and remains valid until the final T ₄ of the cycle (M = HIGH, IO = LOW). M/ \overline{IO} floats to 3-state OFF in local bus "hold acknowledge".
\overline{WR}	29	O	WRITE: indicates that the processor is performing a write memory or write I/O cycle, depending on the state of the M/ \overline{IO} signal. \overline{WR} is active for T ₂ , T ₃ and T _W of any write cycle. It is active LOW, and floats to 3-state OFF in local bus "hold acknowledge".
\overline{INTA}	24	O	\overline{INTA}: is used as a read strobe for interrupt acknowledge cycles. It is active LOW during T ₂ , T ₃ and T _W of each interrupt acknowledge cycle.
ALE	25	O	ADDRESS LATCH ENABLE: provided by the processor to latch the address into the 8282/8283 address latch. It is a HIGH pulse active during T ₁ of any bus cycle. Note that ALE is never floated.
DT/ \overline{R}	27	O	DATA TRANSMIT/RECEIVE: needed in minimum system that desires to use an 8286/8287 data bus transceiver. It is used to control the direction of data flow through the transceiver. Logically DT/ \overline{R} is equivalent to S ₁ in the maximum mode, and its timing is the same as for M/ \overline{IO} . (T = HIGH, R = LOW.) This signal floats to 3-state OFF in local bus "hold acknowledge".
\overline{DEN}	26	O	DATA ENABLE: provided as an output enable for the 8286/8287 in a minimum system which uses the transceiver. \overline{DEN} is active LOW during each memory and I/O access and for \overline{INTA} cycles. For a read or \overline{INTA} cycle it is active from the middle of T ₂ until the middle of T ₄ , while for a write cycle it is active from the beginning of T ₂ until the middle of T ₄ . \overline{DEN} floats to 3-state OFF in local bus "hold acknowledge".
HOLD, HLDA	31, 30	I/O	HOLD: indicates that another master is requesting a local bus "hold." To be acknowledged, HOLD must be active HIGH. The processor receiving the "hold" request will issue HLDA (HIGH) as an acknowledgement in the middle of a T ₄ or T ₁ clock cycle. Simultaneous with the issuance of HLDA the processor will float the local bus and control lines. After HOLD is detected as being LOW, the processor will LOWER the HLDA, and when the processor needs to run another cycle, it will again drive the local bus and control lines. Hold acknowledge (HLDA) and HOLD have internal pull-up resistors. The same rules as for $\overline{RQ}/\overline{GT}$ apply regarding when the local bus will be released. HOLD is not an asynchronous input. External synchronization should be provided if the system cannot otherwise guarantee the setup time.

FUNCTIONAL DESCRIPTION

General Operation

The internal functions of the 8086 processor are partitioned logically into two processing units. The first is the Bus Interface Unit (BIU) and the second is the Execution Unit (EU) as shown in the block diagram of Figure 1.

These units can interact directly but for the most part perform as separate asynchronous operational processors. The bus interface unit provides the functions related to instruction fetching and queuing, operand fetch and store, and address relocation. This unit also provides the basic bus control. The overlap of instruction pre-fetching provided by this unit serves to increase processor performance through improved bus bandwidth utilization. Up to 6 bytes of the instruction stream can be queued while waiting for decoding and execution.

The instruction stream queuing mechanism allows the BIU to keep the memory utilized very efficiently. Whenever there is space for at least 2 bytes in the queue, the BIU will attempt a word fetch memory cycle. This greatly reduces "dead time" on the memory bus. The queue acts as a First-In-First-Out (FIFO) buffer, from which the EU extracts instruction bytes as required. If the queue is empty (following a branch instruction, for example), the first byte into the queue immediately becomes available to the EU.

The execution unit receives pre-fetched instructions from the BIU queue and provides un-relocated operand addresses to the BIU. Memory operands are passed through the BIU for processing by the EU, which passes results to the BIU for storage. See the Instruction Set description for further register set and architectural descriptions.

MEMORY ORGANIZATION

The processor provides a 20-bit address to memory which locates the byte being referenced. The memory is organized as a linear array of up to 1 million

bytes, addressed as 00000(H) to FFFFF(H). The memory is logically divided into code, data, extra data, and stack segments of up to 64K bytes each, with each segment falling on 16-byte boundaries. (See Figure 3a.)

All memory references are made relative to base addresses contained in high speed segment registers. The segment types were chosen based on the addressing needs of programs. The segment register to be selected is automatically chosen according to the rules of the following table. All information in one segment type share the same logical attributes (e.g. code or data). By structuring memory into relocatable areas of similar characteristics and by automatically selecting segment registers, programs are shorter, faster, and more structured.

Word (16-bit) operands can be located on even or odd address boundaries and are thus not constrained to even boundaries as is the case in many 16-bit computers. For address and data operands, the least significant byte of the word is stored in the lower valued address location and the most significant byte in the next higher address location. The BIU automatically performs the proper number of memory accesses, one if the word operand is on an even byte boundary and two if it is on an odd byte boundary. Except for the performance penalty, this double access is transparent to the software. This performance penalty does not occur for instruction fetches, only word operands.

Physically, the memory is organized as a high bank (D₁₅-D₈) and a low bank (D₇-D₀) of 512K 8-bit bytes addressed in parallel by the processor's address lines A₁₉-A₁. Byte data with even addresses is transferred on the D₇-D₀ bus lines while odd addressed byte data (A₀ HIGH) is transferred on the D₁₅-D₈ bus lines. The processor provides two enable signals, \overline{BHE} and A₀, to selectively allow reading from or writing into either an odd byte location, even byte location, or both. The instruction stream is fetched from memory as words and is addressed internally by the processor to the byte level as necessary.

Memory Reference Need	Segment Register Used	Segment Selection Rule
Instructions	CODE (CS)	Automatic with all instruction prefetch.
Stack	STACK (SS)	All stack pushes and pops. Memory references relative to BP base register except data references.
Local Data	DATA (DS)	Data references when: relative to stack, destination of string operation, or explicitly overridden.
External (Global) Data	EXTRA (ES)	Destination of string operations: explicitly selected using a segment override.

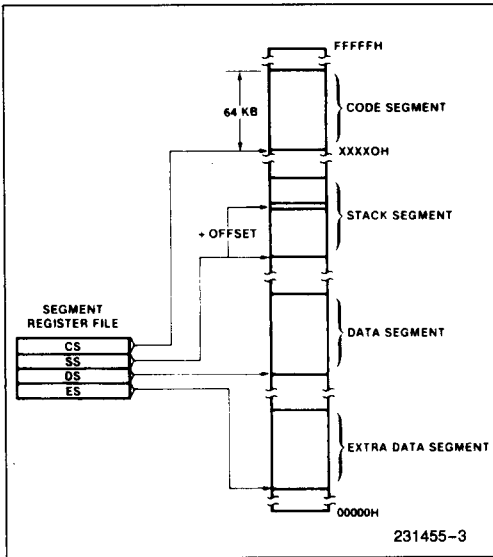

Figure 3a. Memory Organization

In referencing word data the BIU requires one or two memory cycles depending on whether or not the starting byte of the word is on an even or odd address, respectively. Consequently, in referencing word operands performance can be optimized by locating data on even address boundaries. This is an especially useful technique for using the stack, since odd address references to the stack may adversely affect the context switching time for interrupt processing or task multiplexing.

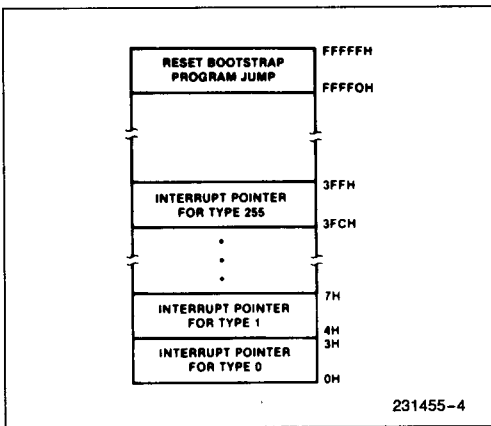

Figure 3b. Reserved Memory Locations

Certain locations in memory are reserved for specific CPU operations (see Figure 3b). Locations from

address FFFF0H through FFFFFH are reserved for operations including a jump to the initial program loading routine. Following RESET, the CPU will always begin execution at location FFFF0H where the jump must be. Locations 00000H through 003FFH are reserved for interrupt operations. Each of the 256 possible interrupt types has its service routine pointed to by a 4-byte pointer element consisting of a 16-bit segment address and a 16-bit offset address. The pointer elements are assumed to have been stored at the respective places in reserved memory prior to occurrence of interrupts.

MINIMUM AND MAXIMUM MODES

The requirements for supporting minimum and maximum 8086 systems are sufficiently different that they cannot be done efficiently with 40 uniquely defined pins. Consequently, the 8086 is equipped with a strap pin (MN/MX) which defines the system configuration. The definition of a certain subset of the pins changes dependent on the condition of the strap pin. When MN/MX pin is strapped to GND, the 8086 treats pins 24 through 31 in maximum mode. An 8288 bus controller interprets status information coded into $\overline{S}_0, \overline{S}_2, \overline{S}_2$ to generate bus timing and control signals compatible with the MULTIBUS architecture. When the MN/MX pin is strapped to VCC, the 8086 generates bus control signals itself on pins 24 through 31, as shown in parentheses in Figure 2. Examples of minimum mode and maximum mode systems are shown in Figure 4.

BUS OPERATION

The 8086 has a combined address and data bus commonly referred to as a time multiplexed bus. This technique provides the most efficient use of pins on the processor while permitting the use of a standard 40-lead package. This "local bus" can be buffered directly and used throughout the system with address latching provided on memory and I/O modules. In addition, the bus can also be demultiplexed at the processor with a single set of address latches if a standard non-multiplexed bus is desired for the system.

Each processor bus cycle consists of at least four CLK cycles. These are referred to as T_1, T_2, T_3 and T_4 (see Figure 5). The address is emitted from the processor during T_1 and data transfer occurs on the bus during T_3 and T_4 . T_2 is used primarily for changing the direction of the bus during read operations. In the event that a "NOT READY" indication is given by the addressed device, "Wait" states (T_W) are inserted between T_3 and T_4 . Each inserted "Wait" state is of the same duration as a CLK cycle. Periods

3

can occur between 8086 bus cycles. These are referred to as "Idle" states (T_i) or inactive CLK cycles. The processor uses these cycles for internal house-keeping.

During T_1 of any bus cycle the ALE (Address Latch Enable) signal is emitted (by either the processor or the 8288 bus controller, depending on the MN/MX strap). At the trailing edge of this pulse, a valid address and certain status information for the cycle may be latched.

Status bits $\overline{S_0}$, $\overline{S_1}$, and $\overline{S_2}$ are used, in maximum mode, by the bus controller to identify the type of bus transaction according to the following table:

$\overline{S_2}$	$\overline{S_1}$	$\overline{S_0}$	Characteristics
0 (LOW)	0	0	Interrupt Acknowledge
0	0	1	Read I/O
0	1	0	Write I/O
0	1	1	Halt
1 (HIGH)	0	0	Instruction Fetch
1	0	1	Read Data from Memory
1	1	0	Write Data to Memory
1	1	1	Passive (no bus cycle)

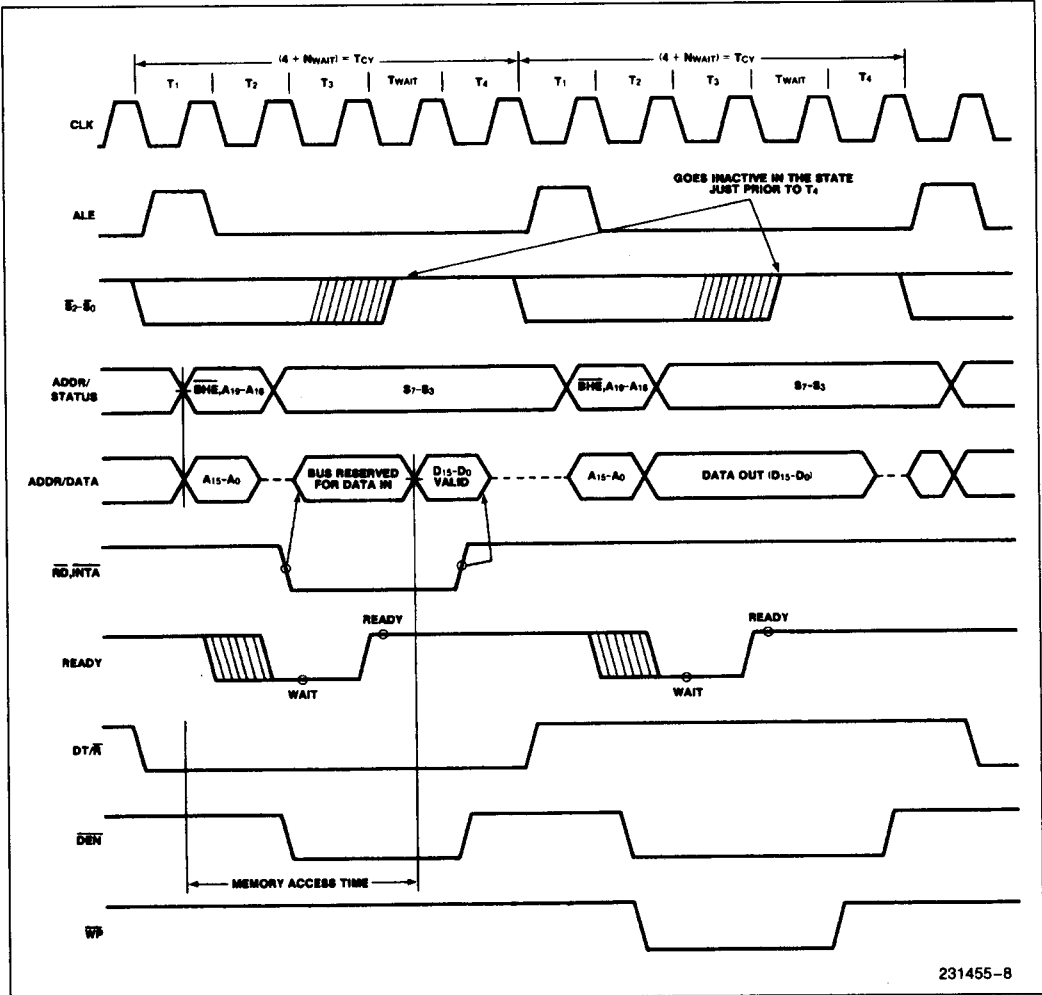

3

Figure 5. Basic System Timing

231455-8

Status bits S_3 through S_7 are multiplexed with high-order address bits and the BHE signal, and are therefore valid during T_2 through T_4 . S_3 and S_4 indicate which segment register (see Instruction Set description) was used for this bus cycle in forming the address, according to the following table:

S_4	S_3	Characteristics
0 (LOW)	0	Alternate Data (extra segment)
0	1	Stack
1 (HIGH)	0	Code or None
1	1	Data

S_5 is a reflection of the PSW interrupt enable bit. $S_6 = 0$ and S_7 is a spare status bit.

I/O ADDRESSING

In the 8086, I/O operations can address up to a maximum of 64K I/O byte registers or 32K I/O word registers. The I/O address appears in the same format as the memory address on bus lines A_{15} – A_0 . The address lines A_{19} – A_{16} are zero in I/O operations. The variable I/O instructions which use register DX as a pointer have full address capability while the direct I/O instructions directly address one or two of the 256 I/O byte locations in page 0 of the I/O address space.

I/O ports are addressed in the same manner as memory locations. Even addressed bytes are transferred on the D_7 – D_0 bus lines and odd addressed bytes on D_{15} – D_8 . Care must be taken to assure that each register within an 8-bit peripheral located on the lower portion of the bus be addressed as even.

External Interface

PROCESSOR RESET AND INITIALIZATION

Processor initialization or start up is accomplished with activation (HIGH) of the RESET pin. The 8086 RESET is required to be HIGH for greater than 4 CLK cycles. The 8086 will terminate operations on the high-going edge of RESET and will remain dormant as long as RESET is HIGH. The low-going transition of RESET triggers an internal reset sequence for approximately 10 CLK cycles. After this interval the 8086 operates normally beginning with the instruction in absolute location FFFF0H (see Figure 3b). The details of this operation are specified in the Instruction Set description of the MCS-86 Family User's Manual. The RESET input is internally synchronized to the processor clock. At initialization the HIGH-to-LOW transition of RESET must occur no sooner than 50 μ s after power-up, to allow complete initialization of the 8086.

NMI asserted prior to the 2nd clock after the end of RESET will not be honored. If NMI is asserted after that point and during the internal reset sequence, the processor may execute one instruction before responding to the interrupt. A hold request active immediately after RESET will be honored before the first instruction fetch.

All 3-state outputs float to 3-state OFF during RESET. Status is active in the idle state for the first clock after RESET becomes active and then floats to 3-state OFF. ALE and HLDA are driven low.

INTERRUPT OPERATIONS

Interrupt operations fall into two classes; software or hardware initiated. The software initiated interrupts and software aspects of hardware interrupts are specified in the Instruction Set description. Hardware interrupts can be classified as non-maskable or maskable.

Interrupts result in a transfer of control to a new program location. A 256-element table containing address pointers to the interrupt service program locations resides in absolute locations 0 through 3FFH (see Figure 3b), which are reserved for this purpose. Each element in the table is 4 bytes in size and corresponds to an interrupt "type". An interrupting device supplies an 8-bit type number, during the interrupt acknowledge sequence, which is used to "vector" through the appropriate element to the new interrupt service program location.

NON-MASKABLE INTERRUPT (NMI)

The processor provides a single non-maskable interrupt pin (NMI) which has higher priority than the maskable interrupt request pin (INTR). A typical use would be to activate a power failure routine. The NMI is edge-triggered on a LOW-to-HIGH transition. The activation of this pin causes a type 2 interrupt. (See Instruction Set description.)

NMI is required to have a duration in the HIGH state of greater than two CLK cycles, but is not required to be synchronized to the clock. Any high-going transition of NMI is latched on-chip and will be serviced at the end of the current instruction or between whole moves of a block-type instruction. Worst case response to NMI would be for multiply, divide, and variable shift instructions. There is no specification on the occurrence of the low-going edge; it may occur before, during, or after the servicing of NMI. Another high-going edge triggers another response if it occurs after the start of the NMI procedure. The signal must be free of logical spikes in general and be free of bounces on the low-going edge to avoid triggering extraneous responses.

MASKABLE INTERRUPT (INTR)

The 8086 provides a single interrupt request input (INTR) which can be masked internally by software with the resetting of the interrupt enable FLAG status bit. The interrupt request signal is level triggered. It is internally synchronized during each clock cycle on the high-going edge of CLK. To be responded to, INTR must be present (HIGH) during the clock period preceding the end of the current instruction or the end of a whole move for a block-type instruction. During the interrupt response sequence further interrupts are disabled. The enable bit is reset as part of the response to any interrupt (INTR, NMI, software interrupt or single-step), although the FLAGS register which is automatically pushed onto the stack reflects the state of the processor prior to the interrupt. Until the old FLAGS register is restored the enable bit will be zero unless specifically set by an instruction.

During the response sequence (Figure 6) the processor executes two successive (back-to-back) interrupt acknowledge cycles. The 8086 emits the LOCK signal from T₂ of the first bus cycle until T₂ of the second. A local bus "hold" request will not be honored until the end of the second bus cycle. In the second bus cycle a byte is fetched from the external interrupt system (e.g., 8259A PIC) which identifies the source (type) of the interrupt. This byte is multiplied by four and used as a pointer into the interrupt vector lookup table. An INTR signal left HIGH will be continually responded to within the limitations of the enable bit and sample period. The INTERRUPT RETURN instruction includes a FLAGS pop which returns the status of the original interrupt enable bit when it restores the FLAGS.

HALT

When a software "HALT" instruction is executed the processor indicates that it is entering the "HALT" state in one of two ways depending upon which mode is strapped. In minimum mode, the processor issues one ALE with no qualifying bus control signals. In maximum mode, the processor issues appropriate HALT status on S₂, S₁, and S₀; and the 8288 bus controller issues one ALE. The 8086 will not leave the "HALT" state when a local bus "hold" is entered while in "HALT". In this case, the processor reissues the HALT indicator. An interrupt request or RESET will force the 8086 out of the "HALT" state.

READ/MODIFY/WRITE (SEMAPHORE) OPERATIONS VIA LOCK

The LOCK status information is provided by the processor when directly consecutive bus cycles are required during the execution of an instruction. This provides the processor with the capability of performing read/modify/write operations on memory (via the Exchange Register With Memory instruction, for example) without the possibility of another system bus master receiving intervening memory cycles. This is useful in multi-processor system configurations to accomplish "test and set lock" operations. The LOCK signal is activated (forced LOW) in the clock cycle following the one in which the software "LOCK" prefix instruction is decoded by the EU. It is deactivated at the end of the last bus cycle of the instruction following the "LOCK" prefix instruction. While LOCK is active a request on a RQ/GT pin will be recorded and then honored at the end of the LOCK.

3

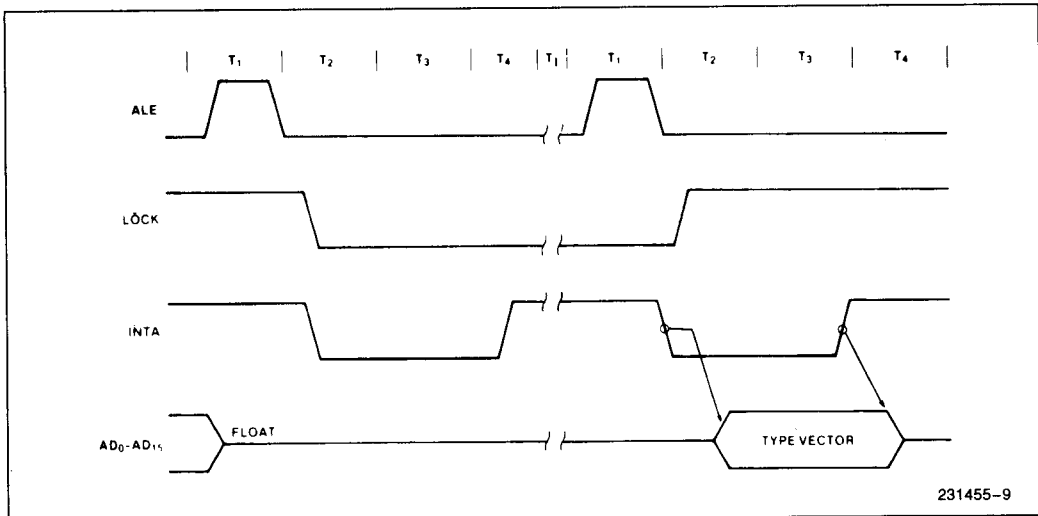

Figure 6. Interrupt Acknowledge Sequence

EXTERNAL SYNCHRONIZATION VIA TEST

As an alternative to the interrupts and general I/O capabilities, the 8086 provides a single software-testable input known as the $\overline{\text{TEST}}$ signal. At any time the program may execute a WAIT instruction. If at that time the $\overline{\text{TEST}}$ signal is inactive (HIGH), program execution becomes suspended while the processor waits for $\overline{\text{TEST}}$ to become active. It must remain active for at least 5 CLK cycles. The WAIT instruction is re-executed repeatedly until that time. This activity does not consume bus cycles. The processor remains in an idle state while waiting. All 8086 drivers go to 3-state OFF if bus "Hold" is entered. If interrupts are enabled, they may occur while the processor is waiting. When this occurs the processor fetches the WAIT instruction one extra time, processes the interrupt, and then re-fetches and re-executes the WAIT instruction upon returning from the interrupt.

Basic System Timing

Typical system configurations for the processor operating in minimum mode and in maximum mode are shown in Figures 4a and 4b, respectively. In minimum mode, the $\text{MN}/\overline{\text{MX}}$ pin is strapped to V_{CC} and the processor emits bus control signals in a manner similar to the 8085. In maximum mode, the $\text{MN}/\overline{\text{MX}}$ pin is strapped to V_{SS} and the processor emits coded status information which the 8288 bus controller uses to generate MULTIBUS compatible bus control signals. Figure 5 illustrates the signal timing relationships.

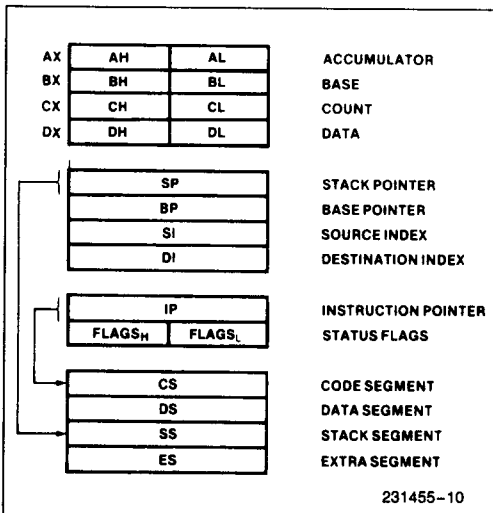

Figure 7. 8086 Register Model

SYSTEM TIMING—MINIMUM SYSTEM

The read cycle begins in T_1 with the assertion of the Address Latch Enable (ALE) signal. The trailing (low-going) edge of this signal is used to latch the address information, which is valid on the local bus at this time, into the address latch. The $\overline{\text{BHE}}$ and A_0 signals address the low, high, or both bytes. From T_1 to T_4 the $\text{M}/\overline{\text{IO}}$ signal indicates a memory or I/O operation. At T_2 the address is removed from the local bus and the bus goes to a high impedance state. The read control signal is also asserted at T_2 . The read ($\overline{\text{RD}}$) signal causes the addressed device to enable its data bus drivers to the local bus. Some time later valid data will be available on the bus and the addressed device will drive the READY line HIGH. When the processor returns the read signal to a HIGH level, the addressed device will again 3-state its bus drivers. If a transceiver is required to buffer the 8086 local bus, signals $\text{DT}/\overline{\text{R}}$ and $\overline{\text{DEN}}$ are provided by the 8086.

A write cycle also begins with the assertion of ALE and the emission of the address. The $\text{M}/\overline{\text{IO}}$ signal is again asserted to indicate a memory or I/O write operation. In the T_2 immediately following the address emission the processor emits the data to be written into the addressed location. This data remains valid until the middle of T_4 . During T_2 , T_3 , and T_W the processor asserts the write control signal. The write ($\overline{\text{WR}}$) signal becomes active at the beginning of T_2 as opposed to the read which is delayed somewhat into T_2 to provide time for the bus to float.

The $\overline{\text{BHE}}$ and A_0 signals are used to select the proper byte(s) of the memory/I/O word to be read or written according to the following table:

$\overline{\text{BHE}}$	A_0	Characteristics
0	0	Whole word
0	1	Upper byte from/to odd address
1	0	Lower byte from/to even address
1	1	None

I/O ports are addressed in the same manner as memory location. Even addressed bytes are transferred on the $\text{D}_7\text{--}\text{D}_0$ bus lines and odd addressed bytes on $\text{D}_{15}\text{--}\text{D}_8$.

The basic difference between the interrupt acknowledge cycle and a read cycle is that the interrupt acknowledge signal ($\overline{\text{INTA}}$) is asserted in place of the read ($\overline{\text{RD}}$) signal and the address bus is floated. (See Figure 6.) In the second of two successive $\overline{\text{INTA}}$ cycles, a byte of information is read from bus

lines D₇–D₀ as supplied by the interrupt system logic (i.e., 8259A Priority Interrupt Controller). This byte identifies the source (type) of the interrupt. It is multiplied by four and used as a pointer into an interrupt vector lookup table, as described earlier.

BUS TIMING—MEDIUM SIZE SYSTEMS

For medium size systems the MN/ $\overline{\text{MX}}$ pin is connected to V_{SS} and the 8288 Bus Controller is added to the system as well as a latch for latching the system address, and a transceiver to allow for bus loading greater than the 8086 is capable of handling. Signals ALE, DEN, and DT/ $\overline{\text{R}}$ are generated by the 8288 instead of the processor in this configuration although their timing remains relatively the same. The 8086 status outputs ($\overline{\text{S}}_2$, $\overline{\text{S}}_1$, and $\overline{\text{S}}_0$) provide type-of-cycle information and become 8288 inputs. This bus cycle information specifies read (code, data, or I/O), write (data or I/O), interrupt

acknowledge, or software halt. The 8288 thus issues control signals specifying memory read or write, I/O read or write, or interrupt acknowledge. The 8288 provides two types of write strobes, normal and advanced, to be applied as required. The normal write strobes have data valid at the leading edge of write. The advanced write strobes have the same timing as read strobes, and hence data isn't valid at the leading edge of write. The transceiver receives the usual DIR and $\overline{\text{G}}$ inputs from the 8288's DT/ $\overline{\text{R}}$ and DEN.

The pointer into the interrupt vector table, which is passed during the second INTA cycle, can derive from an 8259A located on either the local bus or the system bus. If the master 8259A Priority Interrupt Controller is positioned on the local bus, a TTL gate is required to disable the transceiver when reading from the master 8259A during the interrupt acknowledge sequence and software "poll".

ABSOLUTE MAXIMUM RATINGS*

Ambient Temperature Under Bias 0°C to 70°C

Storage Temperature -65°C to +150°C

Voltage on Any Pin with

Respect to Ground -1.0V to +7V

Power Dissipation 2.5W

NOTICE: This is a production data sheet. The specifications are subject to change without notice.

*WARNING: Stressing the device beyond the "Absolute Maximum Ratings" may cause permanent damage. These are stress ratings only. Operation beyond the "Operating Conditions" is not recommended and extended exposure beyond the "Operating Conditions" may affect device reliability.

D.C. CHARACTERISTICS (8086: $T_A = 0^\circ\text{C}$ to 70°C , $V_{CC} = 5\text{V} \pm 10\%$)
 (8086-1: $T_A = 0^\circ\text{C}$ to 70°C , $V_{CC} = 5\text{V} \pm 5\%$)
 (8086-2: $T_A = 0^\circ\text{C}$ to 70°C , $V_{CC} = 5\text{V} \pm 5\%$)

Symbol	Parameter	Min	Max	Units	Test Conditions
V_{IL}	Input Low Voltage	-0.5	+0.8	V	(Note 1)
V_{IH}	Input High Voltage	2.0	$V_{CC} + 0.5$	V	(Notes 1, 2)
V_{OL}	Output Low Voltage		0.45	V	$I_{OL} = 2.5\text{ mA}$
V_{OH}	Output High Voltage	2.4		V	$I_{OH} = -400\ \mu\text{A}$
I_{CC}	Power Supply Current: 8086 8086-1 8086-2		340 360 350	mA	$T_A = 25^\circ\text{C}$
I_{LI}	Input Leakage Current		± 10	μA	$0\text{V} \leq V_{IN} \leq V_{CC}$ (Note 3)
I_{LO}	Output Leakage Current		± 10	μA	$0.45\text{V} \leq V_{OUT} \leq V_{CC}$
V_{CL}	Clock Input Low Voltage	-0.5	+0.6	V	
V_{CH}	Clock Input High Voltage	3.9	$V_{CC} + 1.0$	V	
C_{IN}	Capacitance of Input Buffer (All input except AD_0 - AD_{15} , $\overline{RQ}/\overline{GT}$)		15	pF	$f_c = 1\text{ MHz}$
C_{IO}	Capacitance of I/O Buffer (AD_0 - AD_{15} , $\overline{RQ}/\overline{GT}$)		15	pF	$f_c = 1\text{ MHz}$

NOTES:

- V_{IL} tested with $\overline{MN}/\overline{MX}$ Pin = 0V. V_{IH} tested with $\overline{MN}/\overline{MX}$ Pin = 5V. $\overline{MN}/\overline{MX}$ Pin is a Strap Pin.
- Not applicable to $\overline{RQ}/\overline{GT0}$ and $\overline{RQ}/\overline{GT1}$ (Pins 30 and 31).
- HOLD and HLDA I_{LI} min = 30 μA , max = 500 μA .

A.C. CHARACTERISTICS (8086: $T_A = 0^\circ\text{C}$ to 70°C , $V_{CC} = 5\text{V} \pm 10\%$)
 (8086-1: $T_A = 0^\circ\text{C}$ to 70°C , $V_{CC} = 5\text{V} \pm 5\%$)
 (8086-2: $T_A = 0^\circ\text{C}$ to 70°C , $V_{CC} = 5\text{V} \pm 5\%$)

MINIMUM COMPLEXITY SYSTEM TIMING REQUIREMENTS

Symbol	Parameter	8086		8086-1		8086-2		Units	Test Conditions
		Min	Max	Min	Max	Min	Max		
TCLCL	CLK Cycle Period	200	500	100	500	125	500	ns	
TCLCH	CLK Low Time	118		53		68		ns	
TCHCL	CLK High Time	69		39		44		ns	
TCH1CH2	CLK Rise Time		10		10		10	ns	From 1.0V to 3.5V
TCL2CL1	CLK Fall Time		10		10		10	ns	From 3.5V to 1.0V
TDVCL	Data in Setup Time	30		5		20		ns	
TCLDX	Data in Hold Time	10		10		10		ns	
TR1VCL	RDY Setup Time into 8284A (See Notes 1, 2)	35		35		35		ns	
TCLR1X	RDY Hold Time into 8284A (See Notes 1, 2)	0		0		0		ns	
TRYHCH	READY Setup Time into 8086	118		53		68		ns	
TCHRYX	READY Hold Time into 8086	30		20		20		ns	
TRYLCL	READY Inactive to CLK (See Note 3)	-8		-10		-8		ns	
THVCH	HOLD Setup Time	35		20		20		ns	
TINVCH	INTR, NMI, $\overline{\text{TEST}}$ Setup Time (See Note 2)	30		15		15		ns	
TILIH	Input Rise Time (Except CLK)		20		20		20	ns	From 0.8V to 2.0V
TIHIL	Input Fall Time (Except CLK)		12		12		12	ns	From 2.0V to 0.8V

3

A.C. CHARACTERISTICS (Continued)

TIMING RESPONSES

Symbol	Parameter	8086		8086-1		8086-2		Units	Test Conditions
		Min	Max	Min	Max	Min	Max		
TCLAV	Address Valid Delay	10	110	10	50	10	60	ns	*C _L = 20–100 pF for all 8086 Outputs (In addition to 8086 selfload)
TCLAX	Address Hold Time	10		10		10		ns	
TCLAZ	Address Float Delay	TCLAX	80	10	40	TCLAX	50	ns	
TLHLL	ALE Width	TCLCH-20		TCLCH-10		TCLCH-10		ns	
TCLLH	ALE Active Delay		80		40		50	ns	
TCHLL	ALE Inactive Delay		85		45		55	ns	
TLLAX	Address Hold Time	TCHCL-10		TCHCL-10		TCHCL-10		ns	
TCLDV	Data Valid Delay	10	110	10	50	10	60	ns	
TCHDX	Data Hold Time	10		10		10		ns	
TWHDX	Data Hold Time After WR	TCLCH-30		TCLCH-25		TCLCH-30		ns	
TCVTV	Control Active Delay 1	10	110	10	50	10	70	ns	
TCHCTV	Control Active Delay 2	10	110	10	45	10	60	ns	
TCVCTX	Control Inactive Delay	10	110	10	50	10	70	ns	
TAZRL	Address Float to READ Active	0		0		0		ns	
TCLRL	\overline{RD} Active Delay	10	165	10	70	10	100	ns	
TCLRH	\overline{RD} Inactive Delay	10	150	10	60	10	80	ns	
TRHAV	\overline{RD} Inactive to Next Address Active	TCLCL-45		TCLCL-35		TCLCL-40		ns	
TCLHAV	HLDA Valid Delay	10	160	10	60	10	100	ns	
TRLRH	\overline{RD} Width	2TCLCL-75		2TCLCL-40		2TCLCL-50		ns	
TWLWH	\overline{WR} Width	2TCLCL-60		2TCLCL-35		2TCLCL-40		ns	
TAVAL	Address Valid to ALE Low	TCLCH-60		TCLCH-35		TCLCH-40		ns	
TOLOH	Output Rise Time		20		20		20	ns	From 0.8V to 2.0V
TOHOL	Output Fall Time		12		12		12	ns	From 2.0V to 0.8V

NOTES:

- Signal at 8284A shown for reference only.
- Setup requirement for asynchronous signal only to guarantee recognition at next CLK.
- Applies only to T2 state. (8 ns into T3).

A.C. TESTING INPUT, OUTPUT WAVEFORM

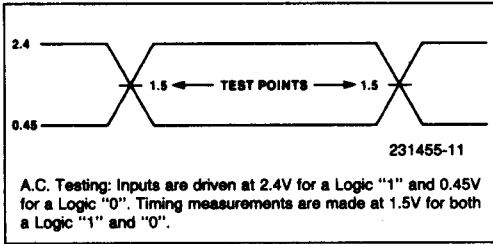

A.C. TESTING LOAD CIRCUIT

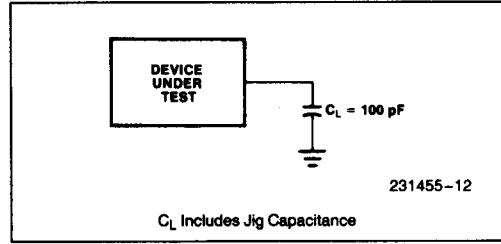

WAVEFORMS

MINIMUM MODE

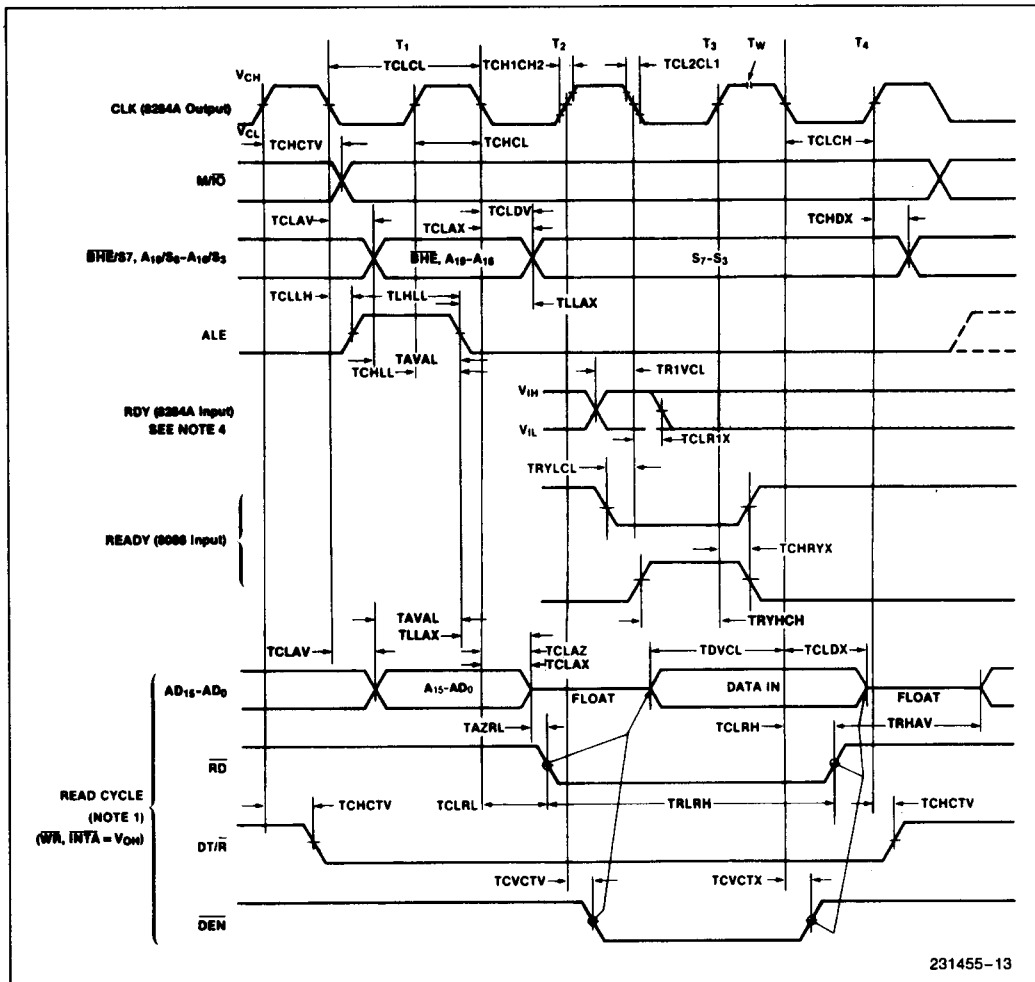

3

A.C. CHARACTERISTICS
**MAX MODE SYSTEM (USING 8288 BUS CONTROLLER)
TIMING REQUIREMENTS**

Symbol	Parameter	8086		8086-1		8086-2		Units	Test Conditions	
		Min	Max	Min	Max	Min	Max			
TCLCL	CLK Cycle Period	200	500	100	500	125	500	ns		
TCLCH	CLK Low Time	118		53		68		ns		
TCHCL	CLK High Time	69		39		44		ns		
TCH1CH2	CLK Rise Time		10		10		10	ns	From 1.0V to 3.5V	
TCL2CL1	CLK Fall Time		10		10		10	ns	From 3.5V to 1.0V	
TDVCL	Data in Setup Time	30		5		20		ns		
TCLDX	Data in Hold Time	10		10		10		ns		
TR1VCL	RDY Setup Time into 8284A (Notes 1, 2)	35		35		35		ns		
TCLR1X	RDY Hold Time into 8284A (Notes 1, 2)	0		0		0		ns		
TRYHCH	READY Setup Time into 8086	118		53		68		ns		
TCHRYX	READY Hold Time into 8086	30		20		20		ns		
TRYLCL	READY Inactive to CLK (Note 4)	-8		-10		-8		ns		
TINVCH	Setup Time for Recognition (INTR, NMI, TEST) (Note 2)	30		15		15		ns		
TGVCH	$\overline{RQ}/\overline{GT}$ Setup Time (Note 5)	30		15		15		ns		
TCHGX	\overline{RQ} Hold Time into 8086	40		20		30		ns		
TILIH	Input Rise Time (Except CLK)		20		20		20	ns		From 0.8V to 2.0V
TIHIL	Input Fall Time (Except CLK)		12		12		12	ns		From 2.0V to 0.8V

3

A.C. CHARACTERISTICS (Continued)

TIMING RESPONSES

Symbol	Parameter	8086		8086-1		8086-2		Units	Test Conditions
		Min	Max	Min	Max	Min	Max		
TCLML	Command Active Delay (See Note 1)	10	35	10	35	10	35	ns	C _L = 20–100 pF for all 8086 Outputs (in addition to 8086 self-load)
TCLMH	Command Inactive Delay (See Note 1)	10	35	10	35	10	35	ns	
TRYHSH	READY Active to Status Passive (See Note 3)		110		45		65	ns	
TCHSV	Status Active Delay	10	110	10	45	10	60	ns	
TCLSH	Status Inactive Delay	10	130	10	55	10	70	ns	
TCLAV	Address Valid Delay	10	110	10	50	10	60	ns	
TCLAX	Address Hold Time	10		10		10		ns	
TCLAZ	Address Float Delay	TCLAX	80	10	40	TCLAX	50	ns	
TSVLH	Status Valid to ALE High (See Note 1)		15		15		15	ns	
TSMVCH	Status Valid to MCE High (See Note 1)		15		15		15	ns	
TCLLH	CLK Low to ALE Valid (See Note 1)		15		15		15	ns	
TCLMCH	CLK Low to MCE High (See Note 1)		15		15		15	ns	
TCHLL	ALE Inactive Delay (See Note 1)		15		15		15	ns	
TCLMCL	MCE Inactive Delay (See Note 1)		15		15		15	ns	
TCLDV	Data Valid Delay	10	110	10	50	10	60	ns	
TCHDX	Data Hold Time	10		10		10		ns	
TCVNV	Control Active Delay (See Note 1)	5	45	5	45	5	45	ns	
TCVNX	Control Inactive Delay (See Note 1)	10	45	10	45	10	45	ns	
TAZRL	Address Float to READ Active	0		0		0		ns	
TCLRL	RD Active Delay	10	165	10	70	10	100	ns	
TCLRH	RD Inactive Delay	10	150	10	60	10	80	ns	

A.C. CHARACTERISTICS (Continued)

TIMING RESPONSES (Continued)

Symbol	Parameter	8086		8086-1		8086-2		Units	Test Conditions	
		Min	Max	Min	Max	Min	Max			
TRHAV	RD Inactive to Next Address Active	TCLCL-45		TCLCL-35		TCLCL-40		ns	C _L = 20–100 pF for all 8086 Outputs (In addition to 8086 self-load)	
TCHDTL	Direction Control Active Delay (Note 1)		50		50		50	ns		
TCHDTH	Direction Control Inactive Delay (Note 1)		30		30		30	ns		
TCLGL	GT Active Delay	0	85	0	38	0	50	ns		
TCLGH	GT Inactive Delay	0	85	0	45	0	50	ns		
TRLRH	RD Width	2TCLCL-75		2TCLCL-40		2TCLCL-50		ns		
TOLOH	Output Rise Time		20		20		20	ns		From 0.8V to 2.0V
TOHOL	Output Fall Time		12		12		12	ns		From 2.0V to 0.8V

3

NOTES:

1. Signal at 8284A or 8288 shown for reference only.
2. Setup requirement for asynchronous signal only to guarantee recognition at next CLK.
3. Applies only to T3 and wait states.
4. Applies only to T2 state (8 ns into T3).

WAVEFORMS (Continued)

ASYNCHRONOUS SIGNAL RECOGNITION

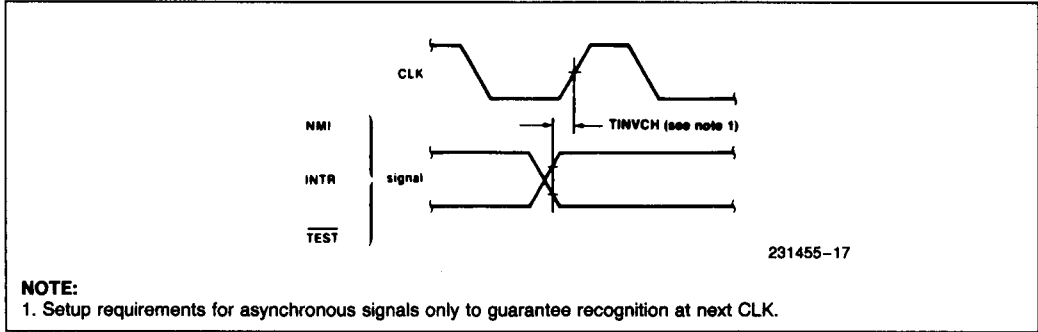

BUS LOCK SIGNAL TIMING (MAXIMUM MODE ONLY)

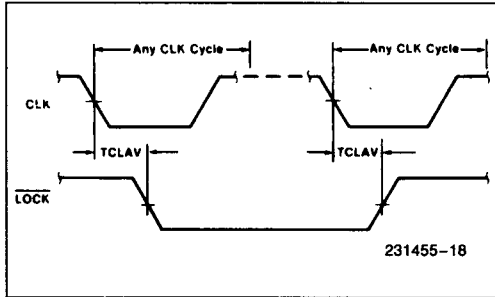

RESET TIMING

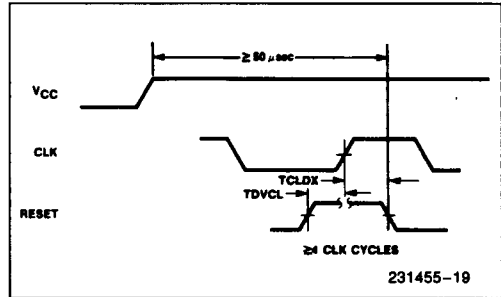

REQUEST/GRANT SEQUENCE TIMING (MAXIMUM MODE ONLY)

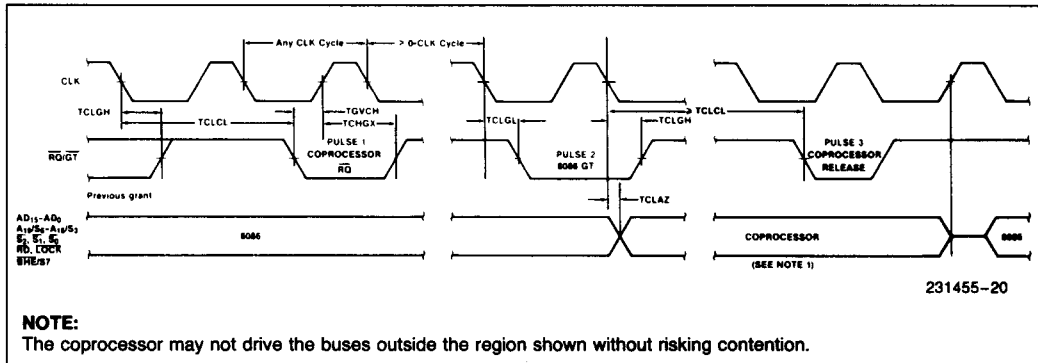

WAVEFORMS (Continued)

HOLD/HOLD ACKNOWLEDGE TIMING (MINIMUM MODE ONLY)

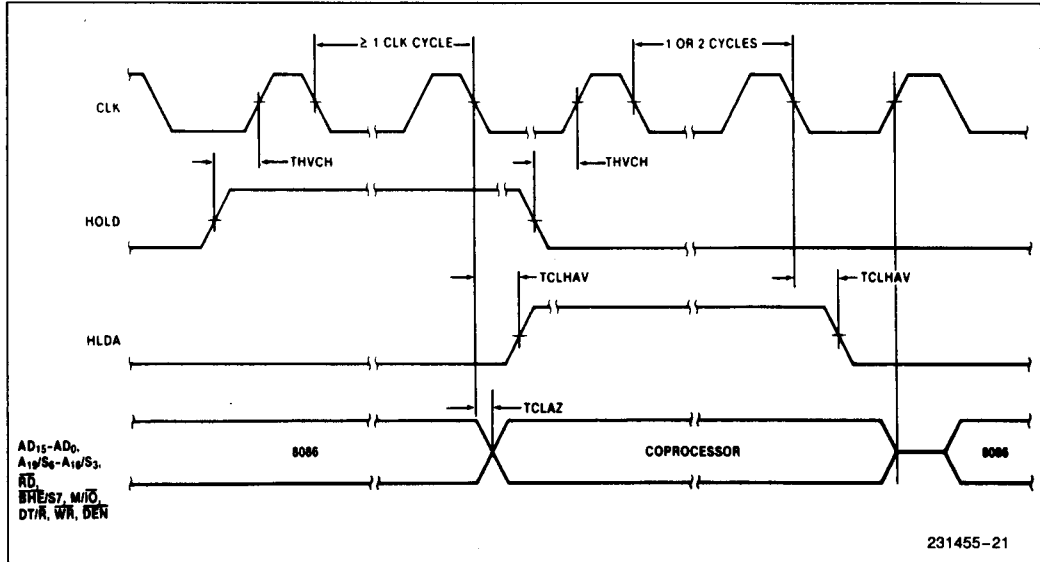

Table 2. Instruction Set Summary

Mnemonic and Description	Instruction Code			
DATA TRANSFER				
MOV = Move:	7 6 5 4 3 2 1 0	7 6 5 4 3 2 1 0	7 6 5 4 3 2 1 0	7 6 5 4 3 2 1 0
Register/Memory to/from Register	1 0 0 0 1 0 d w	mod reg r/m		
Immediate to Register/Memory	1 1 0 0 0 1 1 w	mod 0 0 0 r/m	data	data if w = 1
Immediate to Register	1 0 1 1 w reg	data	data if w = 1	
Memory to Accumulator	1 0 1 0 0 0 0 w	addr-low	addr-high	
Accumulator to Memory	1 0 1 0 0 0 1 w	addr-low	addr-high	
Register/Memory to Segment Register	1 0 0 0 1 1 1 0	mod 0 reg r/m		
Segment Register to Register/Memory	1 0 0 0 1 1 0 0	mod 0 reg r/m		
PUSH = Push:				
Register/Memory	1 1 1 1 1 1 1 1	mod 1 1 0 r/m		
Register	0 1 0 1 0 reg			
Segment Register	0 0 0 reg 1 1 0			
POP = Pop:				
Register/Memory	1 0 0 0 1 1 1 1	mod 0 0 0 r/m		
Register	0 1 0 1 1 reg			
Segment Register	0 0 0 reg 1 1 1			
XCHG = Exchange:				
Register/Memory with Register	1 0 0 0 0 1 1 w	mod reg r/m		
Register with Accumulator	1 0 0 1 0 reg			
IN = Input from:				
Fixed Port	1 1 1 0 0 1 0 w	port		
Variable Port	1 1 1 0 1 1 0 w			
OUT = Output to:				
Fixed Port	1 1 1 0 0 1 1 w	port		
Variable Port	1 1 1 0 1 1 1 w			
XLAT = Translate Byte to AL	1 1 0 1 0 1 1 1			
LEA = Load EA to Register	1 0 0 0 1 1 0 1	mod reg r/m		
LDS = Load Pointer to DS	1 1 0 0 0 1 0 1	mod reg r/m		
LES = Load Pointer to ES	1 1 0 0 0 1 0 0	mod reg r/m		
LAHF = Load AH with Flags	1 0 0 1 1 1 1 1			
SAHF = Store AH into Flags	1 0 0 1 1 1 1 0			
PUSHF = Push Flags	1 0 0 1 1 1 0 0			
POPF = Pop Flags	1 0 0 1 1 1 0 1			

Mnemonics © Intel, 1978

Table 2. Instruction Set Summary (Continued)

Mnemonic and Description	Instruction Code			
	7 6 5 4 3 2 1 0	7 6 5 4 3 2 1 0	7 6 5 4 3 2 1 0	7 6 5 4 3 2 1 0
ARITHMETIC				
ADD = Add:				
Reg./Memory with Register to Either	0 0 0 0 0 d w	mod reg r/m		
Immediate to Register/Memory	1 0 0 0 0 s w	mod 0 0 0 r/m	data	data if s w = 0 1
Immediate to Accumulator	0 0 0 0 0 1 0 w	data	data if w = 1	
ADC = Add with Carry:				
Reg./Memory with Register to Either	0 0 0 1 0 d w	mod reg r/m		
Immediate to Register/Memory	1 0 0 0 0 s w	mod 0 1 0 r/m	data	data if s w = 0 1
Immediate to Accumulator	0 0 0 1 0 1 0 w	data	data if w = 1	
INC = Increment:				
Register/Memory	1 1 1 1 1 1 1 w	mod 0 0 0 r/m		
Register	0 1 0 0 0 reg			
AAA = ASCII Adjust for Add	0 0 1 1 0 1 1 1			
BAA = Decimal Adjust for Add	0 0 1 0 0 1 1 1			
SUB = Subtract:				
Reg./Memory and Register to Either	0 0 1 0 1 d w	mod reg r/m		
Immediate from Register/Memory	1 0 0 0 0 s w	mod 1 0 1 r/m	data	data if s w = 0 1
Immediate from Accumulator	0 0 1 0 1 1 0 w	data	data if w = 1	
SSB = Subtract with Borrow				
Reg./Memory and Register to Either	0 0 0 1 1 d w	mod reg r/m		
Immediate from Register/Memory	1 0 0 0 0 s w	mod 0 1 1 r/m	data	data if s w = 0 1
Immediate from Accumulator	0 0 0 1 1 1 w	data	data if w = 1	
DEC = Decrement:				
Register/memory	1 1 1 1 1 1 1 w	mod 0 0 1 r/m		
Register	0 1 0 0 1 reg			
NEG = Change sign	1 1 1 1 0 1 1 w	mod 0 1 1 r/m		
CMP = Compare:				
Register/Memory and Register	0 0 1 1 1 d w	mod reg r/m		
Immediate with Register/Memory	1 0 0 0 0 s w	mod 1 1 1 r/m	data	data if s w = 0 1
Immediate with Accumulator	0 0 1 1 1 1 0 w	data	data if w = 1	
AAS = ASCII Adjust for Subtract	0 0 1 1 1 1 1 1			
DAS = Decimal Adjust for Subtract	0 0 1 0 1 1 1 1			
MUL = Multiply (Unsigned)	1 1 1 1 0 1 1 w	mod 1 0 0 r/m		
IMUL = Integer Multiply (Signed)	1 1 1 1 0 1 1 w	mod 1 0 1 r/m		
AAM = ASCII Adjust for Multiply	1 1 0 1 0 1 0 0	0 0 0 0 1 0 1 0		
DIV = Divide (Unsigned)	1 1 1 1 0 1 1 w	mod 1 1 0 r/m		
IDIV = Integer Divide (Signed)	1 1 1 1 0 1 1 w	mod 1 1 1 r/m		
AAD = ASCII Adjust for Divide	1 1 0 1 0 1 0 1	0 0 0 0 1 0 1 0		
CBW = Convert Byte to Word	1 0 0 1 1 0 0 0			
CWD = Convert Word to Double Word	1 0 0 1 1 0 0 1			

3

Table 2. Instruction Set Summary (Continued)

Mnemonic and Description	Instruction Code			
	7 6 5 4 3 2 1 0	7 6 5 4 3 2 1 0	7 6 5 4 3 2 1 0	7 6 5 4 3 2 1 0
LOGIC				
NOT = Invert	1 1 1 1 0 1 1 w	mod 0 1 0 r/m		
SHL/SAL = Shift Logical/Arithmetic Left	1 1 0 1 0 0 v w	mod 1 0 0 r/m		
SHR = Shift Logical Right	1 1 0 1 0 0 v w	mod 1 0 1 r/m		
SAR = Shift Arithmetic Right	1 1 0 1 0 0 v w	mod 1 1 1 r/m		
ROL = Rotate Left	1 1 0 1 0 0 v w	mod 0 0 0 r/m		
ROR = Rotate Right	1 1 0 1 0 0 v w	mod 0 0 1 r/m		
RCL = Rotate Through Carry Flag Left	1 1 0 1 0 0 v w	mod 0 1 0 r/m		
RCR = Rotate Through Carry Right	1 1 0 1 0 0 v w	mod 0 1 1 r/m		
AND = And:				
Reg./Memory and Register to Either	0 0 1 0 0 0 d w	mod reg r/m		
Immediate to Register/Memory	1 0 0 0 0 0 w	mod 1 0 0 r/m	data	data if w = 1
Immediate to Accumulator	0 0 1 0 0 1 0 w	data	data if w = 1	
TEST = And Function to Flags, No Result:				
Register/Memory and Register	1 0 0 0 0 1 0 w	mod reg r/m		
Immediate Data and Register/Memory	1 1 1 1 0 1 1 w	mod 0 0 0 r/m	data	data if w = 1
Immediate Data and Accumulator	1 0 1 0 1 0 0 w	data	data if w = 1	
OR = Or:				
Reg./Memory and Register to Either	0 0 0 0 1 0 d w	mod reg r/m		
Immediate to Register/Memory	1 0 0 0 0 0 w	mod 0 0 1 r/m	data	data if w = 1
Immediate to Accumulator	0 0 0 0 1 1 0 w	data	data if w = 1	
XOR = Exclusive or:				
Reg./Memory and Register to Either	0 0 1 1 0 0 d w	mod reg r/m		
Immediate to Register/Memory	1 0 0 0 0 0 w	mod 1 1 0 r/m	data	data if w = 1
Immediate to Accumulator	0 0 1 1 0 1 0 w	data	data if w = 1	
STRING MANIPULATION				
REP = Repeat	1 1 1 1 0 0 1 z			
MOVS = Move Byte/Word	1 0 1 0 0 1 0 w			
CMPS = Compare Byte/Word	1 0 1 0 0 1 1 w			
SCAS = Scan Byte/Word	1 0 1 0 1 1 1 w			
LODS = Load Byte/Wd to AL/AX	1 0 1 0 1 1 0 w			
STOS = Stor Byte/Wd from AL/A	1 0 1 0 1 0 1 w			
CONTROL TRANSFER				
CALL = Call:				
Direct within Segment	1 1 1 0 1 0 0 0	disp-low	disp-high	
Indirect within Segment	1 1 1 1 1 1 1 1	mod 0 1 0 r/m		
Direct Intersegment	1 0 0 1 1 0 1 0	offset-low	offset-high	
		seg-low	seg-high	
Indirect Intersegment	1 1 1 1 1 1 1 1	mod 0 1 1 r/m		

Table 2. Instruction Set Summary (Continued)

Mnemonic and Description	Instruction Code		
JMP = Unconditional Jump:	7 6 5 4 3 2 1 0	7 6 5 4 3 2 1 0	7 6 5 4 3 2 1 0
Direct within Segment	1 1 1 0 1 0 0 1	disp-low	disp-high
Direct within Segment-Short	1 1 1 0 1 0 1 1	disp	
Indirect within Segment	1 1 1 1 1 1 1 1	mod 1 0 0 r/m	
Direct Intersegment	1 1 1 0 1 0 1 0	offset-low	offset-high
		seg-low	seg-high
Indirect Intersegment	1 1 1 1 1 1 1 1	mod 1 0 1 r/m	
RET = Return from CALL:			
Within Segment	1 1 0 0 0 1 1 1		
Within Seg Adding Immed to SP	1 1 0 0 0 1 0 1 0	data-low	data-high
Intersegment	1 1 0 0 1 0 1 1 1		
Intersegment Adding Immediate to SP	1 1 0 0 1 0 1 0 1 0	data-low	data-high
JE/JZ = Jump on Equal/Zero	0 1 1 1 0 1 0 0	disp	
JL/JNGE = Jump on Less/Not Greater or Equal	0 1 1 1 1 1 0 0	disp	
JLE/JNG = Jump on Less or Equal/Not Greater	0 1 1 1 1 1 1 0	disp	
JB/JNAE = Jump on Below/Not Above or Equal	0 1 1 1 0 0 1 0	disp	
JBE/JNA = Jump on Below or Equal/Not Above	0 1 1 1 0 1 1 0	disp	
JP/JPE = Jump on Parity/Parity Even	0 1 1 1 1 0 1 0	disp	
JO = Jump on Overflow	0 1 1 1 0 0 0 0	disp	
JS = Jump on Sign	0 1 1 1 1 0 0 0	disp	
JNE/JNZ = Jump on Not Equal/Not Zero	0 1 1 1 0 1 0 1	disp	
JNL/JGE = Jump on Not Less/Greater or Equal	0 1 1 1 1 1 0 1	disp	
JNLE/JG = Jump on Not Less or Equal/Greater	0 1 1 1 1 1 1 1	disp	
JNB/JAE = Jump on Not Below/Above or Equal	0 1 1 1 0 0 1 1	disp	
JNBE/JA = Jump on Not Below or Equal/Above	0 1 1 1 0 1 1 1	disp	
JNP/JPO = Jump on Not Par/Par Odd	0 1 1 1 1 0 1 1	disp	
JNO = Jump on Not Overflow	0 1 1 1 0 0 0 1	disp	
JNS = Jump on Not Sign	0 1 1 1 1 0 0 1	disp	
LOOP = Loop CX Times	1 1 1 0 0 0 1 0	disp	
LOOPZ/LOOPE = Loop While Zero/Equal	1 1 1 0 0 0 0 1	disp	
LOOPNZ/LOOPNE = Loop While Not Zero/Equal	1 1 1 0 0 0 0 0	disp	
JCXZ = Jump on CX Zero	1 1 1 0 0 0 1 1	disp	
INT = Interrupt			
Type Specified	1 1 0 0 1 1 0 1	type	
Type 3	1 1 0 0 1 1 0 0		
INTO = Interrupt on Overflow	1 1 0 0 1 1 1 0		
IRET = Interrupt Return	1 1 0 0 1 1 1 1		

Table 2. Instruction Set Summary (Continued)

Mnemonic and Description	Instruction Code	
	7 6 5 4 3 2 1 0	7 6 5 4 3 2 1 0
PROCESSOR CONTROL		
CLC = Clear Carry	1 1 1 1 1 0 0 0	
CMC = Complement Carry	1 1 1 1 0 1 0 1	
STC = Set Carry	1 1 1 1 1 0 0 1	
CLD = Clear Direction	1 1 1 1 1 1 0 0	
STD = Set Direction	1 1 1 1 1 1 0 1	
CLI = Clear Interrupt	1 1 1 1 1 0 1 0	
STI = Set Interrupt	1 1 1 1 1 0 1 1	
HLT = Halt	1 1 1 1 0 1 0 0	
WAIT = Wait	1 0 0 1 1 0 1 1	
ESC = Escape (to External Device)	1 1 0 1 1 x x x	mod x x x r/m
LOCK = Bus Lock Prefix	1 1 1 1 0 0 0 0	

NOTES:

AL = 8-bit accumulator

AX = 16-bit accumulator

CX = Count register

DS = Data segment

ES = Extra segment

Above/below refers to unsigned value

Greater = more positive;

Less = less positive (more negative) signed values

if d = 1 then "to" reg; if d = 0 then "from" reg

if w = 1 then word instruction; if w = 0 then byte instruction

if mod = 11 then r/m is treated as a REG field

if mod = 00 then DISP = 0*, disp-low and disp-high are absent

if mod = 01 then DISP = disp-low sign-extended to 16 bits, disp-high is absent

if mod = 10 then DISP = disp-high; disp-low

if r/m = 000 then EA = (BX) + (SI) + DISP

if r/m = 001 then EA = (BX) + (DI) + DISP

if r/m = 010 then EA = (BP) + (SI) + DISP

if r/m = 011 then EA = (BP) + (DI) + DISP

if r/m = 100 then EA = (SI) + DISP

if r/m = 101 then EA = (DI) + DISP

if r/m = 110 then EA = (BP) + DISP*

if r/m = 111 then EA = (BX) + DISP

DISP follows 2nd byte of instruction (before data if required)

*except if mod = 00 and r/m = 110 then EA = disp-high; disp-low.

Mnemonics © Intel, 1978

if s w = 01 then 16 bits of immediate data form the operand

if s w = 11 then an immediate data byte is sign extended to form the 16-bit operand

if v = 0 then "count" = 1; if v = 1 then "count" in (CL) x = don't care

z is used for string primitives for comparison with ZF FLAG

SEGMENT OVERRIDE PREFIX

0 0 1 reg 1 1 0

REG is assigned according to the following table:

16-Bit (w = 1)	8-Bit (w = 0)	Segment
000 AX	000 AL	00 ES
001 CX	001 CL	01 CS
010 DX	010 DL	10 SS
011 BX	011 BL	11 DS
100 SP	100 AH	
101 BP	101 CH	
110 SI	110 DH	
111 DI	111 BH	

Instructions which reference the flag register file as a 16-bit object use the symbol FLAGS to represent the file:

FLAGS = X:X:X:(OF):(DF):(IF):(TF):(SF):(ZF):X:(AF):X:(PF):X:(CF)

DATA SHEET REVISION REVIEW

The following list represents key differences between this and the -004 data sheet. Please review this summary carefully.

1. The Intel 8086 implementation technology (HMOS) has been changed to (HMOS-III).
2. Delete all "changes from 1985 Handbook Specification" sentences.