

SN75179B DIFFERENTIAL DRIVER AND RECEIVER PAIR

SLLS003E – OCTOBER 1985 – REVISED JUNE 1998

- Meets or Exceeds the Requirements of TIA/EIA-422-B, TIA/EIA-485-A, and ITU Recommendation V.11
- Bus Voltage Range . . . -7 V to 12 V
- Positive- and Negative-Current Limiting
- Driver Output Capability . . . 60 mA Max
- Driver Thermal-Shutdown Protection
- Receiver Input Impedance . . . $12\text{ k}\Omega$ Min
- Receiver Input Sensitivity . . . $\pm 200\text{ mV}$
- Receiver Input Hysteresis . . . 50 mV Typ
- Operates From Single 5-V Supply
- Low Power Requirements

D OR P PACKAGE
(TOP VIEW)

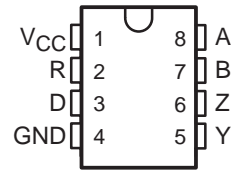

description

The SN75179B is a differential driver and receiver pair designed for balanced transmission-line applications and meets TIA/EIA-422-B, TIA/EIA-485-A, and ITU Recommendation V.11. It is designed to improve the performance of full-duplex data communications over long bus lines.

The SN75179B driver output provides limiting for both positive and negative currents. The receiver features high input impedance, input hysteresis for increased noise immunity, and input sensitivity of $\pm 200\text{ mV}$ over a common-mode input voltage range of -7 V to 12 V . The driver provides thermal shutdown for protection from line fault conditions. Thermal shutdown is designed to occur at a junction temperature of approximately 150°C . The SN75179B is designed to drive current loads of up to 60 mA maximum.

The SN75179B is characterized for operation from 0°C to 70°C .

Function Tables

DRIVER

INPUT D	OUTPUTS	
	Y	Z
H	H	L
L	L	H

RECEIVER

DIFFERENTIAL INPUTS A – B	OUTPUT R
$V_{ID} \geq 0.2\text{ V}$	H
$-0.2\text{ V} < V_{ID} < 0.2\text{ V}$?
$V_{ID} \leq -0.2\text{ V}$	L
Open	?

H = high level, L = low level, ? = indeterminate



Please be aware that an important notice concerning availability, standard warranty, and use in critical applications of Texas Instruments semiconductor products and disclaimers thereto appears at the end of this data sheet.

PRODUCTION DATA information is current as of publication date. Products conform to specifications per the terms of Texas Instruments standard warranty. Production processing does not necessarily include testing of all parameters.

 **TEXAS
INSTRUMENTS**

POST OFFICE BOX 655303 • DALLAS, TEXAS 75265

Copyright © 1998, Texas Instruments Incorporated

SN75179B DIFFERENTIAL DRIVER AND RECEIVER PAIR

SLLS003E – OCTOBER 1985 – REVISED JUNE 1998

logic symbol†

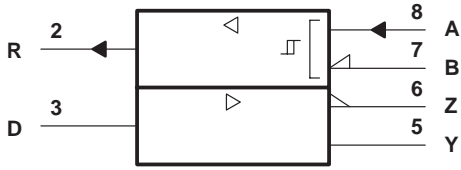

† This symbol is in accordance with ANSI/IEEE Std 91-1984 and IEC Publication 617-12.

logic diagram (positive logic)

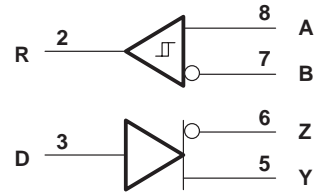

schematics of inputs and outputs

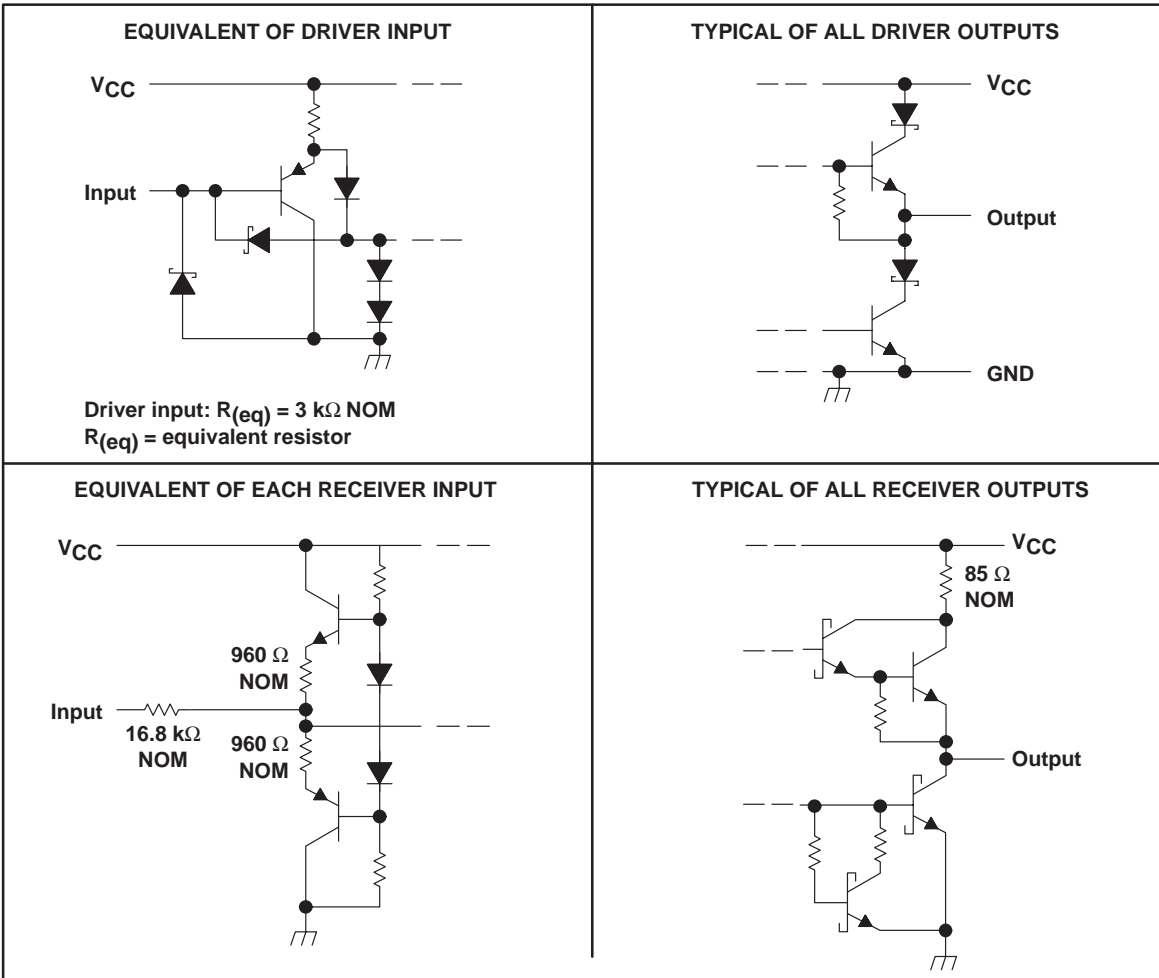

SN75179B DIFFERENTIAL DRIVER AND RECEIVER PAIR

SLLS003E – OCTOBER 1985 – REVISED JUNE 1998

absolute maximum ratings over operating free-air temperature range (unless otherwise noted)†

Supply voltage, V_{CC} (see Note 1)	7 V	
Voltage range at any bus terminal	–10 V to 15 V	
Differential input voltage, V_{ID} (see Note 2)	±25 V	
Package thermal impedance, θ_{JA} (see Note 3):	D package	197°C/W
	P package	104°C/W
Storage temperature range, T_{stg}	–65°C to 150°C	
Lead temperature 1,6 mm (1/16 inch) from case for 10 seconds	260°C	

† Stresses beyond those listed under “absolute maximum ratings” may cause permanent damage to the device. These are stress ratings only, and functional operation of the device at these or any other conditions beyond those indicated under “recommended operating conditions” is not implied. Exposure to absolute-maximum-rated conditions for extended periods may affect device reliability.

- NOTES:
1. All voltage values, except differential input voltage, are with respect to network ground terminal.
 2. Differential input voltage is measured at the noninverting input with respect to the corresponding inverting input.
 3. The package thermal impedance is calculated in accordance with JESD 51, except for through-hole packages, which use a trace length of zero.

recommended operating conditions

		MIN	NOM	MAX	UNIT
Supply voltage, V_{CC}		4.75	5	5.25	V
High-level input voltage, V_{IH}	Driver	2			V
Low-level input voltage, V_{IL}	Driver	0.8			V
Common-mode input voltage, V_{IC}		–7‡		12	V
Differential input voltage, V_{ID}		±12			V
High-level output current, I_{OH}	Driver	–60			mA
	Receiver	–400			µA
Low-level output current, I_{OL}	Driver	60			mA
	Receiver	8			
Operating free-air temperature, T_A		0		70	°C

‡ The algebraic convention, where the less positive (more negative) limit is designated minimum, is used in this data sheet for common-mode input voltage and threshold voltage.



SN75179B DIFFERENTIAL DRIVER AND RECEIVER PAIR

SLLS003E – OCTOBER 1985 – REVISED JUNE 1998

DRIVER SECTION

electrical characteristics over recommended ranges of supply voltage and operating free-air temperature (unless otherwise noted)

PARAMETER	TEST CONDITIONS	MIN	TYP†	MAX	UNIT
V_{IK} Input clamp voltage	$I_I = -18 \text{ mA}$			-1.5	V
V_O Output voltage	$I_O = 0$	0		6	V
$ V_{OD1} $ Differential output voltage	$I_O = 0$	1.5		6	V
$ V_{OD2} $ Differential output voltage	$R_L = 100 \Omega$, See Figure 1	$1/2 V_{OD1}$ or 2^\ddagger			V
	$R_L = 54 \Omega$, See Figure 1	1.5	2.5	5	V
$ V_{OD3} $ Differential output voltage	See Note 4	1.5		5	V
$\Delta V_{OD} $ Change in magnitude of common-mode output voltage§				± 0.2	V
V_{OC} Common-mode output voltage	$R_L = 54 \Omega$ or 100Ω , See Figure 1			$\begin{matrix} 3 \\ -1 \end{matrix}$	V
$\Delta V_{OC} $ Change in magnitude of common-mode output voltage§				± 0.2	V
I_O Output current	$V_{CC} = 0$, $V_O = -7 \text{ V to } 12 \text{ V}$			± 100	μA
I_{IH} High-level input current	$V_I = 2.4 \text{ V}$			20	μA
I_{IL} Low-level input current	$V_I = 0.4 \text{ V}$			-200	μA
I_{OS} Short-circuit output current	$V_O = -7 \text{ V}$			-250	mA
	$V_O = V_{CC}$ or 12 V			250	
I_{CC} Supply current (total package)	No load		57	70	mA

† All typical values are at $V_{CC} = 5 \text{ V}$ and $T_A = 25^\circ\text{C}$.

‡ The minimum V_{OD2} with $100\text{-}\Omega$ load is either $1/2 V_{OD2}$ or 2 V , whichever is greater.

§ $\Delta|V_{OD}|$ and $\Delta|V_{OC}|$ are the changes in magnitude of V_{OD} and V_{OC} , respectively, that occur when the input changes from a high level to a low level.

NOTE 4: See TIA/EIA-485-A, Figure 3.5, Test Termination Measurement 2.

switching characteristics, $V_{CC} = 5 \text{ V}$, $T_A = 25^\circ\text{C}$

PARAMETER	TEST CONDITIONS	MIN	TYP	MAX	UNIT
$t_{d(OD)}$ Differential output delay time	$R_L = 54 \Omega$, See Figure 3		15	22	ns
$t_{t(OD)}$ Differential output transition time			20	30	ns

Symbol Equivalents

DATA-SHEET PARAMETER	TIA/EIA-422-B	TIA/EIA-485-A
V_O	V_{Oa}, V_{Ob}	V_{Oa}, V_{Ob}
$ V_{OD1} $	V_o	V_o
$ V_{OD2} $	$V_t (R_L = 100 \Omega)$	$V_t (R_L = 54 \Omega)$
$ V_{OD3} $		V_t (Test Termination Measurement 2)
$\Delta V_{OD} $	$ V_t - \bar{V}_t $	$ V_t - \bar{V}_t $
V_{OC}	$ V_{os} $	$ V_{os} $
$\Delta V_{OC} $	$ V_{os} - \bar{V}_{os} $	$ V_{os} - \bar{V}_{os} $
I_{OS}	$ I_{sa} , I_{sb} $	
I_O	$ I_{xa} , I_{xb} $	I_{ia}, I_{ib}



RECEIVER SECTION

electrical characteristics over recommended ranges of common-mode input voltage, supply voltage, and operating free-air temperature (unless otherwise noted)

PARAMETER	TEST CONDITIONS	MIN	TYP†	MAX	UNIT
V_{IT+} Positive-going input threshold voltage	$V_O = 2.7\text{ V}$, $I_O = -0.4\text{ mA}$			0.2	V
V_{IT-} Negative-going input threshold voltage	$V_O = 0.5\text{ V}$, $I_O = 8\text{ mA}$	-0.2‡			V
V_{hys} Hysteresis voltage ($V_{IT+} - V_{IT-}$)			50		mV
V_{OH} High-level output voltage	$V_{ID} = 200\text{ mV}$, $I_{OH} = -400\text{ }\mu\text{A}$, See Figure 2		2.7		V
V_{OL} Low-level output voltage	$V_{ID} = -200\text{ mV}$, $I_{OL} = 8\text{ mA}$, See Figure 2			0.45	V
I_I Line input current	Other input at 0 V, See Note 5				mA
				1	
				-0.8	
r_i Input resistance			12		k Ω
I_{OS} Short-circuit output current		-15		-85	mA
I_{CC} Supply current (total package)	No load		57	70	mA

† All typical values are at $V_{CC} = 5\text{ V}$, $T_A = 25^\circ\text{C}$.

‡ The algebraic convention, where the less positive (more negative) limit is designated minimum, is used in this data sheet for common-mode input voltage and threshold voltage levels only.

NOTE 5: Refer to TIA/EIA-422-B for exact conditions.

switching characteristics, $V_{CC} = 5\text{ V}$, $T_A = 25^\circ\text{C}$

PARAMETER	TEST CONDITIONS	MIN	TYP	MAX	UNIT
t_{PLH} Propagation delay time, low- to high-level output	$V_{ID} = -1.5\text{ V}$ to 1.5 V ,		19	35	ns
t_{PHL} Propagation delay time, high- to low-level output	$C_L = 15\text{ pF}$, See Figure 4		30	40	ns

PARAMETER MEASUREMENT INFORMATION

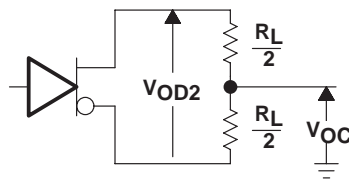

Figure 1. Driver V_{DD} and V_{OC}

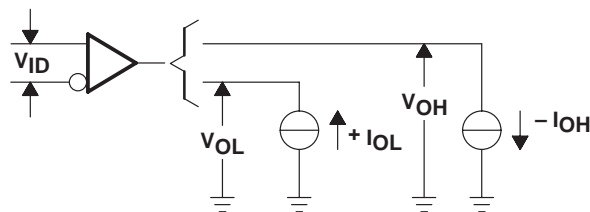
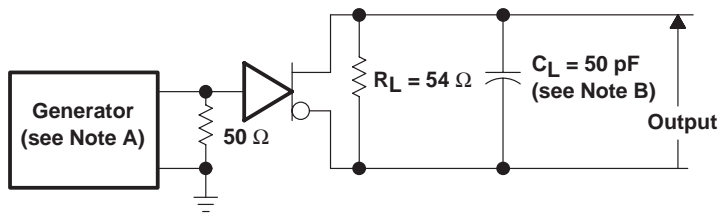

Figure 2. Receiver V_{OH} and V_{OL}

SN75179B DIFFERENTIAL DRIVER AND RECEIVER PAIR

SLLS003E – OCTOBER 1985 – REVISED JUNE 1998

PARAMETER MEASUREMENT INFORMATION (CONTINUED)



TEST CIRCUIT

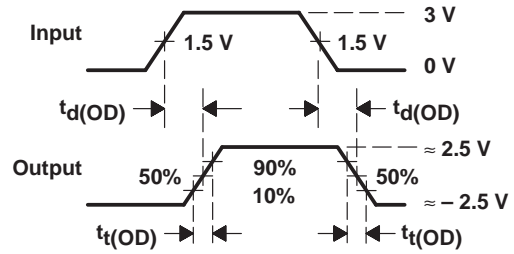

VOLTAGE WAVEFORMS

- NOTES: A. The input pulse is supplied by a generator having the following characteristics: $\text{PRR} \leq 1 \text{ MHz}$, 50% duty cycle, $t_r \leq 6 \text{ ns}$, $t_f \leq 6 \text{ ns}$, $Z_O = 50 \Omega$.
B. C_L includes probe and jig capacitance.

Figure 3. Driver Test Circuit and Voltage Waveforms

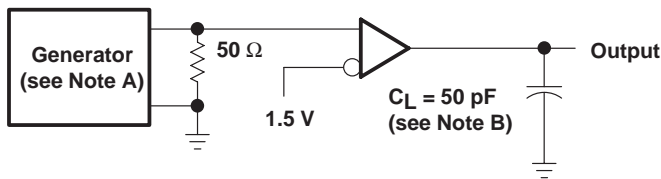

TEST CIRCUIT

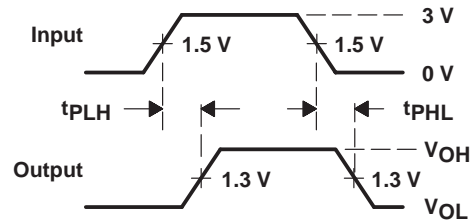

VOLTAGE WAVEFORMS

- NOTES: A. The input pulse is supplied by a generator having the following characteristics: $\text{PRR} \leq 1 \text{ MHz}$, 50% duty cycle, $t_r \leq 6 \text{ ns}$, $t_f \leq 6 \text{ ns}$, $Z_O = 50 \Omega$.
B. C_L includes probe and jig capacitance.

Figure 4. Receiver Test Circuit and Voltage Waveforms

TYPICAL CHARACTERISTICS

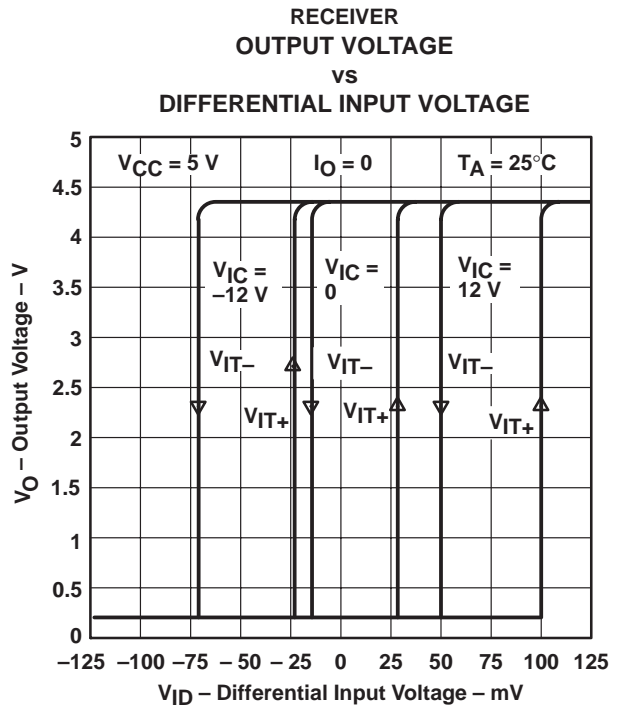
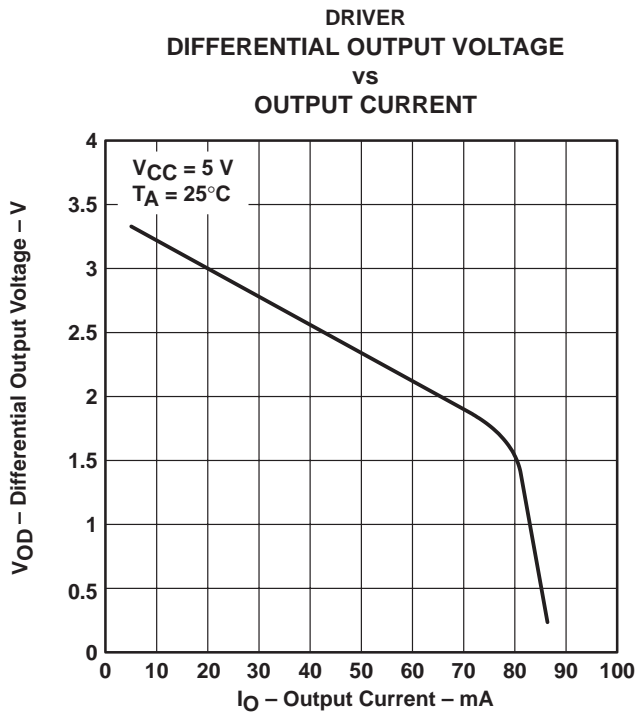
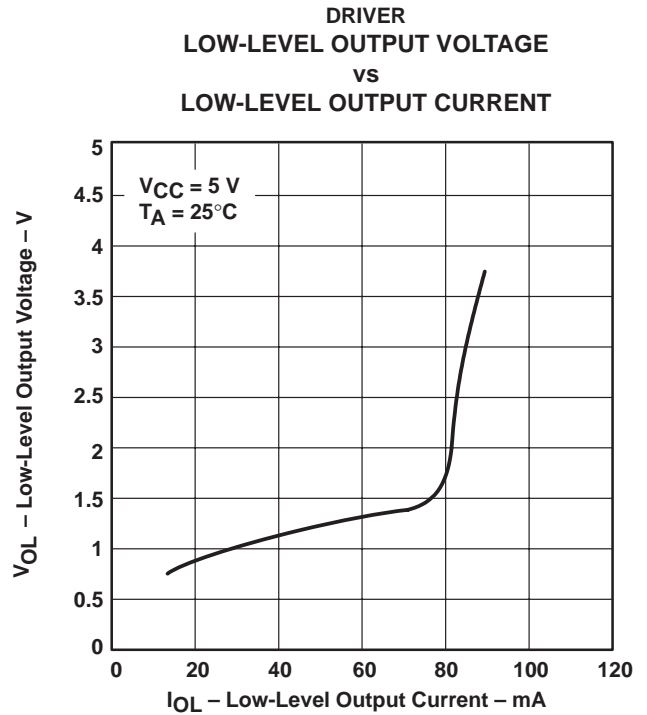
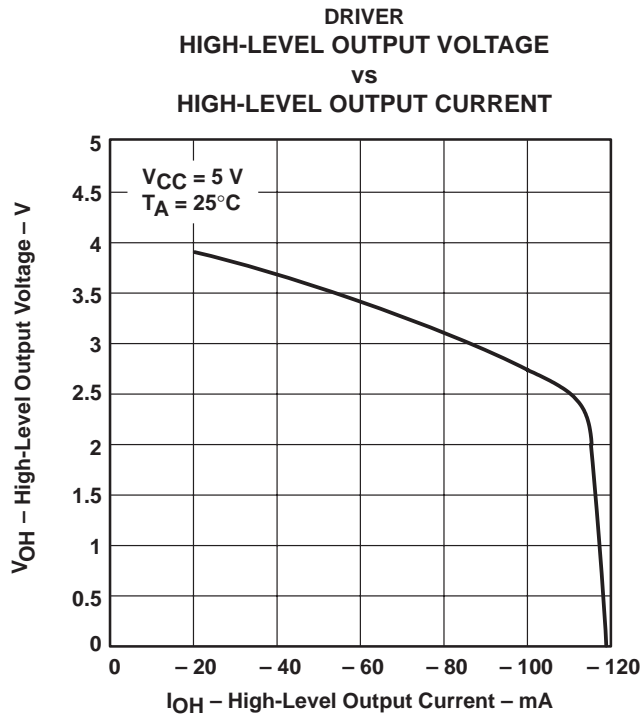

SN75179B DIFFERENTIAL DRIVER AND RECEIVER PAIR

SLLS003E – OCTOBER 1985 – REVISED JUNE 1998

TYPICAL CHARACTERISTICS

HIGH-LEVEL OUTPUT VOLTAGE
vs
HIGH-LEVEL OUTPUT CURRENT

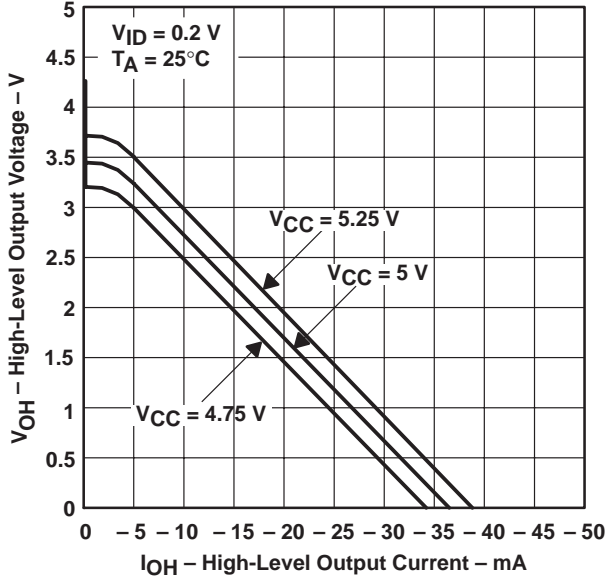

Figure 9

HIGH-LEVEL OUTPUT VOLTAGE
vs
FREE-AIR TEMPERATURE

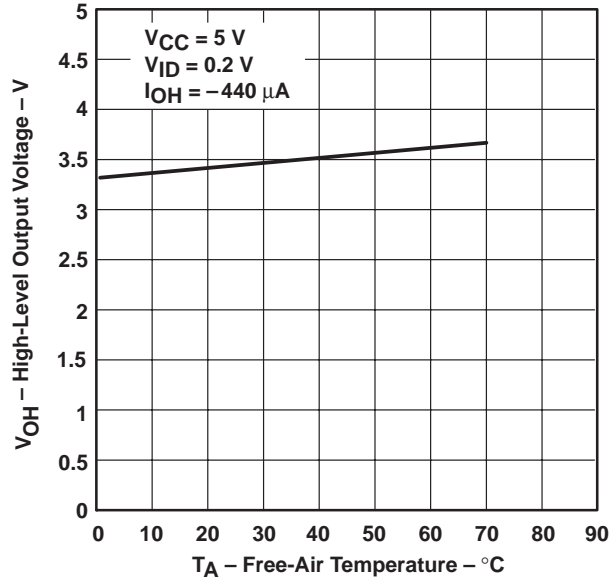

Figure 10

RECEIVER
LOW-LEVEL OUTPUT VOLTAGE
vs
LOW-LEVEL OUTPUT CURRENT

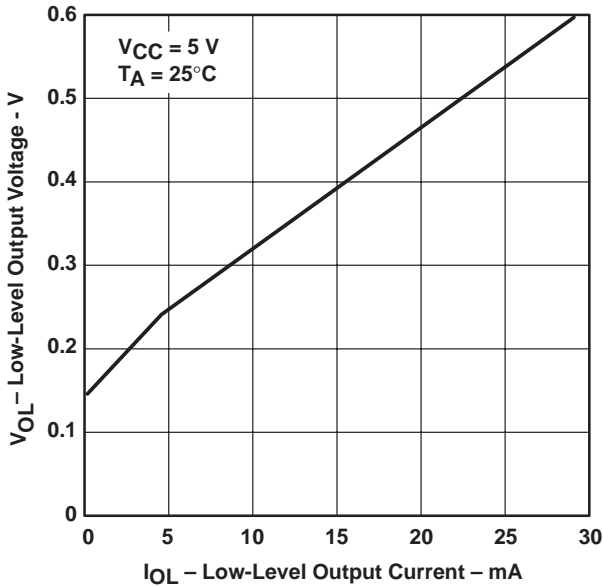

Figure 11

RECEIVER
LOW-LEVEL OUTPUT VOLTAGE
vs
FREE-AIR TEMPERATURE

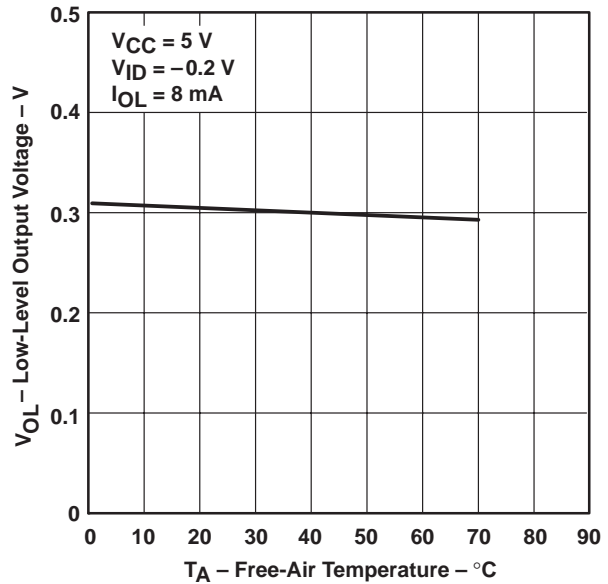

Figure 12

PACKAGING INFORMATION

Orderable Device	Status ⁽¹⁾	Package Type	Package Drawing	Pins	Package Qty	Eco Plan ⁽²⁾	Lead/Ball Finish	MSL Peak Temp ⁽³⁾
SN75179BD	ACTIVE	SOIC	D	8	75	Green (RoHS & no Sb/Br)	CU NIPDAU	Level-1-260C-UNLIM
SN75179BDE4	ACTIVE	SOIC	D	8	75	Green (RoHS & no Sb/Br)	CU NIPDAU	Level-1-260C-UNLIM
SN75179BDG4	ACTIVE	SOIC	D	8	75	Green (RoHS & no Sb/Br)	CU NIPDAU	Level-1-260C-UNLIM
SN75179BDR	ACTIVE	SOIC	D	8	2500	Green (RoHS & no Sb/Br)	CU NIPDAU	Level-1-260C-UNLIM
SN75179BDRE4	ACTIVE	SOIC	D	8	2500	Green (RoHS & no Sb/Br)	CU NIPDAU	Level-1-260C-UNLIM
SN75179BDRG4	ACTIVE	SOIC	D	8	2500	Green (RoHS & no Sb/Br)	CU NIPDAU	Level-1-260C-UNLIM
SN75179BP	ACTIVE	PDIP	P	8	50	Pb-Free (RoHS)	CU NIPDAU	N / A for Pkg Type
SN75179BPE4	ACTIVE	PDIP	P	8	50	Pb-Free (RoHS)	CU NIPDAU	N / A for Pkg Type
SN75179BPSR	ACTIVE	SO	PS	8	2000	Green (RoHS & no Sb/Br)	CU NIPDAU	Level-1-260C-UNLIM
SN75179BPSRE4	ACTIVE	SO	PS	8	2000	Green (RoHS & no Sb/Br)	CU NIPDAU	Level-1-260C-UNLIM
SN75179BPSRG4	ACTIVE	SO	PS	8	2000	Green (RoHS & no Sb/Br)	CU NIPDAU	Level-1-260C-UNLIM

⁽¹⁾ The marketing status values are defined as follows:

ACTIVE: Product device recommended for new designs.

LIFEBUY: TI has announced that the device will be discontinued, and a lifetime-buy period is in effect.

NRND: Not recommended for new designs. Device is in production to support existing customers, but TI does not recommend using this part in a new design.

PREVIEW: Device has been announced but is not in production. Samples may or may not be available.

OBSOLETE: TI has discontinued the production of the device.

⁽²⁾ Eco Plan - The planned eco-friendly classification: Pb-Free (RoHS), Pb-Free (RoHS Exempt), or Green (RoHS & no Sb/Br) - please check <http://www.ti.com/productcontent> for the latest availability information and additional product content details.

TBD: The Pb-Free/Green conversion plan has not been defined.

Pb-Free (RoHS): TI's terms "Lead-Free" or "Pb-Free" mean semiconductor products that are compatible with the current RoHS requirements for all 6 substances, including the requirement that lead not exceed 0.1% by weight in homogeneous materials. Where designed to be soldered at high temperatures, TI Pb-Free products are suitable for use in specified lead-free processes.

Pb-Free (RoHS Exempt): This component has a RoHS exemption for either 1) lead-based flip-chip solder bumps used between the die and package, or 2) lead-based die adhesive used between the die and leadframe. The component is otherwise considered Pb-Free (RoHS compatible) as defined above.

Green (RoHS & no Sb/Br): TI defines "Green" to mean Pb-Free (RoHS compatible), and free of Bromine (Br) and Antimony (Sb) based flame retardants (Br or Sb do not exceed 0.1% by weight in homogeneous material)

⁽³⁾ MSL, Peak Temp. -- The Moisture Sensitivity Level rating according to the JEDEC industry standard classifications, and peak solder temperature.

Important Information and Disclaimer:The information provided on this page represents TI's knowledge and belief as of the date that it is provided. TI bases its knowledge and belief on information provided by third parties, and makes no representation or warranty as to the accuracy of such information. Efforts are underway to better integrate information from third parties. TI has taken and continues to take reasonable steps to provide representative and accurate information but may not have conducted destructive testing or chemical analysis on incoming materials and chemicals. TI and TI suppliers consider certain information to be proprietary, and thus CAS numbers and other limited information may not be available for release.

In no event shall TI's liability arising out of such information exceed the total purchase price of the TI part(s) at issue in this document sold by TI

to Customer on an annual basis.

TAPE AND REEL INFORMATION
REEL DIMENSIONS

TAPE DIMENSIONS

A0	Dimension designed to accommodate the component width
B0	Dimension designed to accommodate the component length
K0	Dimension designed to accommodate the component thickness
W	Overall width of the carrier tape
P1	Pitch between successive cavity centers

TAPE AND REEL INFORMATION

*All dimensions are nominal

Device	Package Type	Package Drawing	Pins	SPQ	Reel Diameter (mm)	Reel Width W1 (mm)	A0 (mm)	B0 (mm)	K0 (mm)	P1 (mm)	W (mm)	Pin1 Quadrant
SN75179BDR	SOIC	D	8	2500	330.0	12.4	6.4	5.2	2.1	8.0	12.0	Q1
SN75179BPSR	SO	PS	8	2000	330.0	16.4	8.2	6.6	2.5	12.0	16.0	Q1

TAPE AND REEL BOX DIMENSIONS

*All dimensions are nominal

Device	Package Type	Package Drawing	Pins	SPQ	Length (mm)	Width (mm)	Height (mm)
SN75179BDR	SOIC	D	8	2500	340.5	338.1	20.6
SN75179BPSR	SO	PS	8	2000	367.0	367.0	38.0

P (R-PDIP-T8)

PLASTIC DUAL-IN-LINE PACKAGE



4040082/E 04/2010

- NOTES:
- A. All linear dimensions are in inches (millimeters).
 - B. This drawing is subject to change without notice.
 - C. Falls within JEDEC MS-001 variation BA.

D (R-PDSO-G8)

PLASTIC SMALL OUTLINE

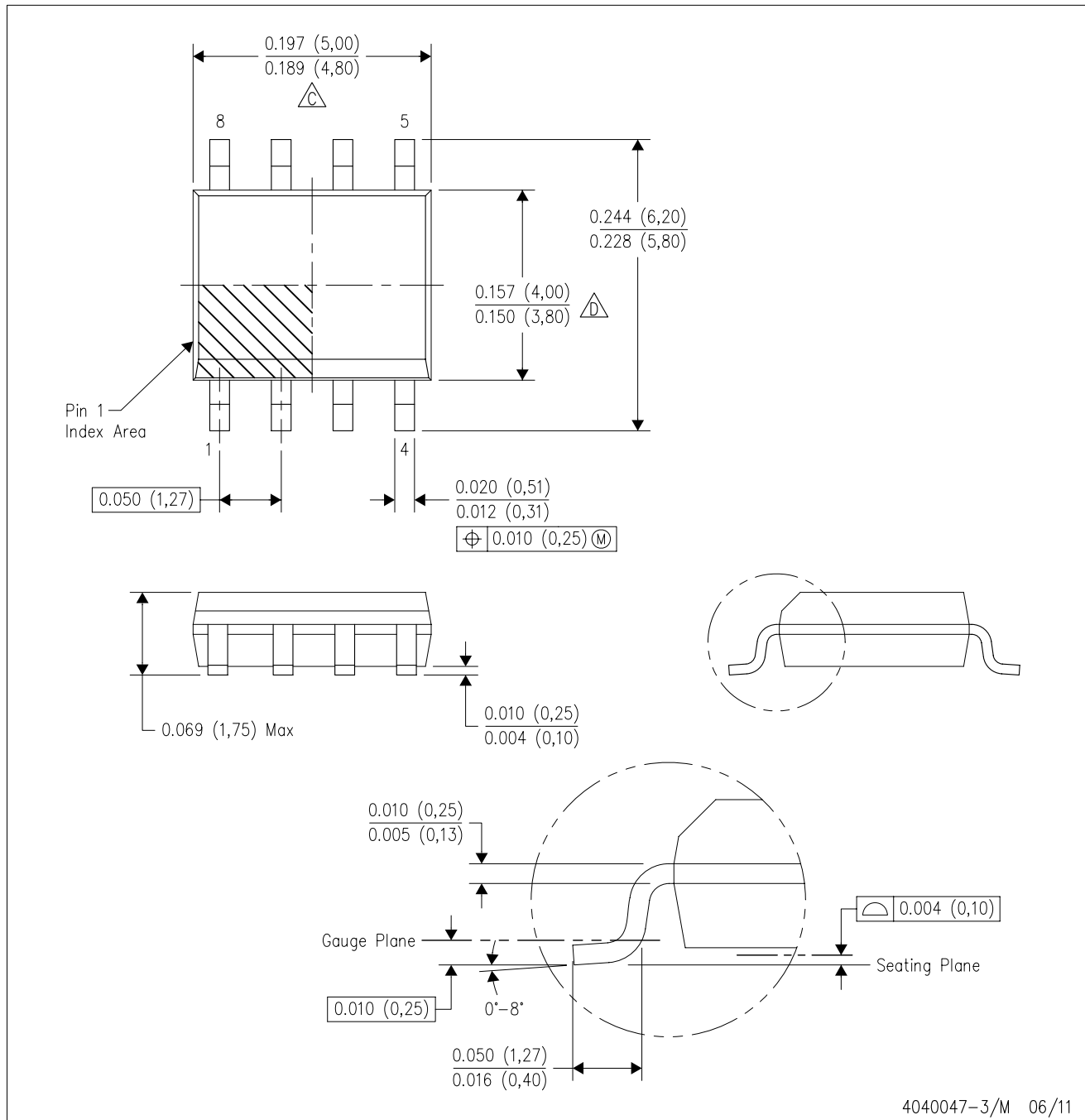

- NOTES:
- A. All linear dimensions are in inches (millimeters).
 - B. This drawing is subject to change without notice.
 - C. Body length does not include mold flash, protrusions, or gate burrs. Mold flash, protrusions, or gate burrs shall not exceed 0.006 (0,15) each side.
 - D. Body width does not include interlead flash. Interlead flash shall not exceed 0.017 (0,43) each side.
 - E. Reference JEDEC MS-012 variation AA.

D (R-PDSO-G8)

PLASTIC SMALL OUTLINE



- NOTES:
- A. All linear dimensions are in millimeters.
 - B. This drawing is subject to change without notice.
 - C. Publication IPC-7351 is recommended for alternate designs.
 - D. Laser cutting apertures with trapezoidal walls and also rounding corners will offer better paste release. Customers should contact their board assembly site for stencil design recommendations. Refer to IPC-7525 for other stencil recommendations.
 - E. Customers should contact their board fabrication site for solder mask tolerances between and around signal pads.

MECHANICAL DATA

PS (R-PDSO-G8)

PLASTIC SMALL-OUTLINE PACKAGE



- NOTES:
- A. All linear dimensions are in millimeters.
 - B. This drawing is subject to change without notice.
 - C. Body dimensions do not include mold flash or protrusion, not to exceed 0,15.

IMPORTANT NOTICE

Texas Instruments Incorporated and its subsidiaries (TI) reserve the right to make corrections, enhancements, improvements and other changes to its semiconductor products and services per JESD46, latest issue, and to discontinue any product or service per JESD48, latest issue. Buyers should obtain the latest relevant information before placing orders and should verify that such information is current and complete. All semiconductor products (also referred to herein as "components") are sold subject to TI's terms and conditions of sale supplied at the time of order acknowledgment.

TI warrants performance of its components to the specifications applicable at the time of sale, in accordance with the warranty in TI's terms and conditions of sale of semiconductor products. Testing and other quality control techniques are used to the extent TI deems necessary to support this warranty. Except where mandated by applicable law, testing of all parameters of each component is not necessarily performed.

TI assumes no liability for applications assistance or the design of Buyers' products. Buyers are responsible for their products and applications using TI components. To minimize the risks associated with Buyers' products and applications, Buyers should provide adequate design and operating safeguards.

TI does not warrant or represent that any license, either express or implied, is granted under any patent right, copyright, mask work right, or other intellectual property right relating to any combination, machine, or process in which TI components or services are used. Information published by TI regarding third-party products or services does not constitute a license to use such products or services or a warranty or endorsement thereof. Use of such information may require a license from a third party under the patents or other intellectual property of the third party, or a license from TI under the patents or other intellectual property of TI.

Reproduction of significant portions of TI information in TI data books or data sheets is permissible only if reproduction is without alteration and is accompanied by all associated warranties, conditions, limitations, and notices. TI is not responsible or liable for such altered documentation. Information of third parties may be subject to additional restrictions.

Resale of TI components or services with statements different from or beyond the parameters stated by TI for that component or service voids all express and any implied warranties for the associated TI component or service and is an unfair and deceptive business practice. TI is not responsible or liable for any such statements.

Buyer acknowledges and agrees that it is solely responsible for compliance with all legal, regulatory and safety-related requirements concerning its products, and any use of TI components in its applications, notwithstanding any applications-related information or support that may be provided by TI. Buyer represents and agrees that it has all the necessary expertise to create and implement safeguards which anticipate dangerous consequences of failures, monitor failures and their consequences, lessen the likelihood of failures that might cause harm and take appropriate remedial actions. Buyer will fully indemnify TI and its representatives against any damages arising out of the use of any TI components in safety-critical applications.

In some cases, TI components may be promoted specifically to facilitate safety-related applications. With such components, TI's goal is to help enable customers to design and create their own end-product solutions that meet applicable functional safety standards and requirements. Nonetheless, such components are subject to these terms.

No TI components are authorized for use in FDA Class III (or similar life-critical medical equipment) unless authorized officers of the parties have executed a special agreement specifically governing such use.

Only those TI components which TI has specifically designated as military grade or "enhanced plastic" are designed and intended for use in military/aerospace applications or environments. Buyer acknowledges and agrees that any military or aerospace use of TI components which have **not** been so designated is solely at the Buyer's risk, and that Buyer is solely responsible for compliance with all legal and regulatory requirements in connection with such use.

TI has specifically designated certain components which meet ISO/TS16949 requirements, mainly for automotive use. Components which have not been so designated are neither designed nor intended for automotive use; and TI will not be responsible for any failure of such components to meet such requirements.

Products

Audio	www.ti.com/audio
Amplifiers	amplifier.ti.com
Data Converters	dataconverter.ti.com
DLP® Products	www.dlp.com
DSP	dsp.ti.com
Clocks and Timers	www.ti.com/clocks
Interface	interface.ti.com
Logic	logic.ti.com
Power Mgmt	power.ti.com
Microcontrollers	microcontroller.ti.com
RFID	www.ti-rfid.com
OMAP Applications Processors	www.ti.com/omap
Wireless Connectivity	www.ti.com/wirelessconnectivity

Applications

Automotive and Transportation	www.ti.com/automotive
Communications and Telecom	www.ti.com/communications
Computers and Peripherals	www.ti.com/computers
Consumer Electronics	www.ti.com/consumer-apps
Energy and Lighting	www.ti.com/energy
Industrial	www.ti.com/industrial
Medical	www.ti.com/medical
Security	www.ti.com/security
Space, Avionics and Defense	www.ti.com/space-avionics-defense
Video and Imaging	www.ti.com/video

TI E2E Community

e2e.ti.com